

Compact kit professional spa

English

Contenido

1. Introduction

2. General warnings

3. Components and connections

4. Installation

4.1. Power supply interruptions

4.2. ESD Warning

4.3. Electrical connections

4.4. Hydraulic connection

5. Operating instructions

5.1. Warnings

5.2. Hot keys

5.3. Configuration menus

5.4. Remote control (Spa buttons)

5.5. System fixed features

5.6. Optional functions

6. Maintenance

6.1. Maintenance warnings

6.2. Acrylic maintenance

6.3. Maintenance in periods of non-use or absence

6.4. Water maintenance

7. Error codes

8. Evidence of conformity

1. Introduction

This manual contains essential information for the proper and safe installation and start up of the system.

Read and strictly follow these instructions. Failure to comply with the instructions may void your warranty and free the manufacturer from any liability.

2. General warnings

- A qualified professional must install, start and perform maintenance on the system in strict adherence to the installation instructions and following all indications given.
- This system may not be plugged into a domestic power line. Verify that the characteristics of the electrical installation meet the system requirements: 3 phases, 400V between each phase and 230V between phase and neutral.
- It is mandatory to comply with all applicable electrical safety standards of the country where the system is installed.
- The safety of people and materials should be ensured. Regulations and established safety codes must be respected.
- The electrical input of the system should always be protected by a highly sensitive RCD (Residual Current Device).
- Use only the highest quality connection, which must be grounded.
- It is essential to choose the appropriate cross section for the cables.
- Check that the thermal magnetic circuit breakers have been calibrated according to the power consumption (amperage).
- Never use the electric control box to connect other equipment.
- No modification is permitted without the express consent of the manufacturer.
- Use only original spare parts supplied by the manufacturer.
- Some elements of the equipment operate at dangerously high voltage. Do not handle them if the system is not completely disconnected from the power supply and start up devices are blocked.
- The limit values which appear on the electric switchboard must not, under any circumstance, exceed the advised amperage.
- Check the wiring and hydraulics before booting the system or connecting it to the power.
- Make sure that no electric component is in contact with water.
- Do not handle the equipment with wet feet.
- Do not switch on the system if the Spa is empty.

3. Components and connections

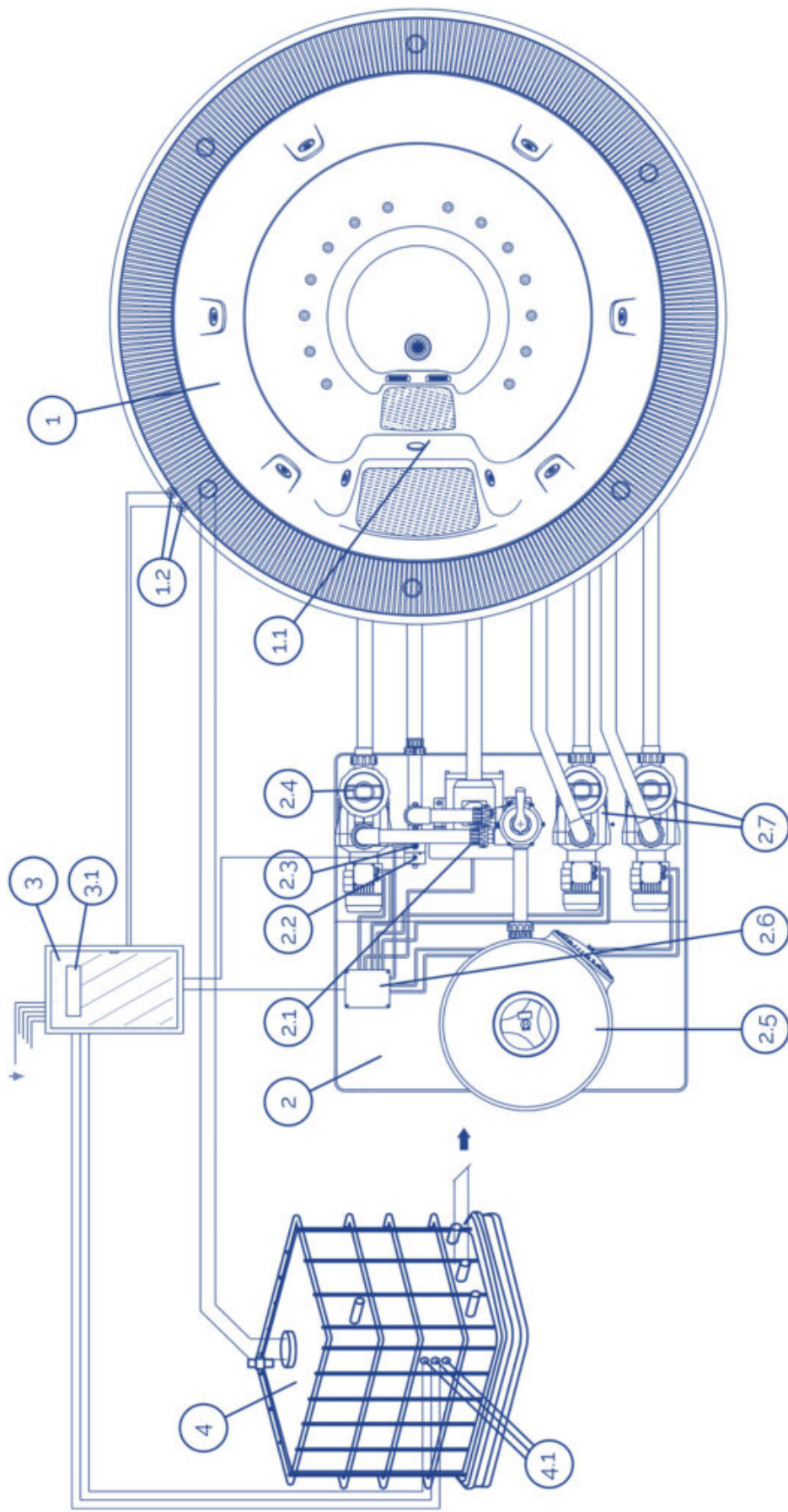

1	SPA	2	HYDRAULIC KIT	2.3	TEMP. SENSOR	2.6	CONNECTION BOX	3.1	CONTROL PANEL
1.1	LIGHT	2.1	BLOWER	2.4	FILTRATION PUMP	2.7	MESSAGE PUMP(S)	4	BALANCE TANK
1.2	CONTROL BUTTONS	2.2	HEATER	2.5	FILTER	3	ELECTRICAL BOARD	4.1	LEVEL SENSORS

4. Installation

4.1. Power supply interruptions

Should the power supply be interrupted, the system will always automatically restart in the operating mode it was in before the interruption.

ATTENTION

After a Power supply interruption the filtration pump will start automatically. Make sure the hydraulic circuit is ready or connect/disconnect necessary items before the power supply will

4.2. ESD Warning

The following precautions must be taken:

Do not open the protective conductive packaging until you are at an approved anti-static work station and have read the following. Use a conductive wrist strap attached to a good earth ground.

Always discharge yourself by touching a grounded bare metal surface or approved anti-static mat before picking up an ESD-sensitive electronic component. Use an approved anti-static mat to cover your work surface. Avoid packaging the PCB into plastic bags, polystyrene or non-antistatic bubble films.

ATTENTION

This product uses components that can be damaged by electrostatic discharge (ESD). When handling, care must be taken so that the devices are not damaged. Damage due to inappropriate handling is not covered by the warranty.

4.3. Electrical connections

Some advices to take into account before doing electrical connections:

- Pumps neutral wire remains free.
- Make sure the power supply is unconnected before starting the installation procedure.
- Respect indicated cable sections and distance between components.

To ensure a proper management of the electronic signals the distance between the components should not exceed the following:

- Electronic push buttons - Electronic Board 15m
- Spa-Hydraulic kit (Pumps).....7m
- Balance Tank (Capacitive level sensors) - Electronic Board..... 15m
- Heater (Temperature sensor) - Electronic Board.....6m
- Solenoid Valve - Electronic Board.....20m

CONNECTION BETWEEN COMPACT KIT AND ELECTRIC CONTROL

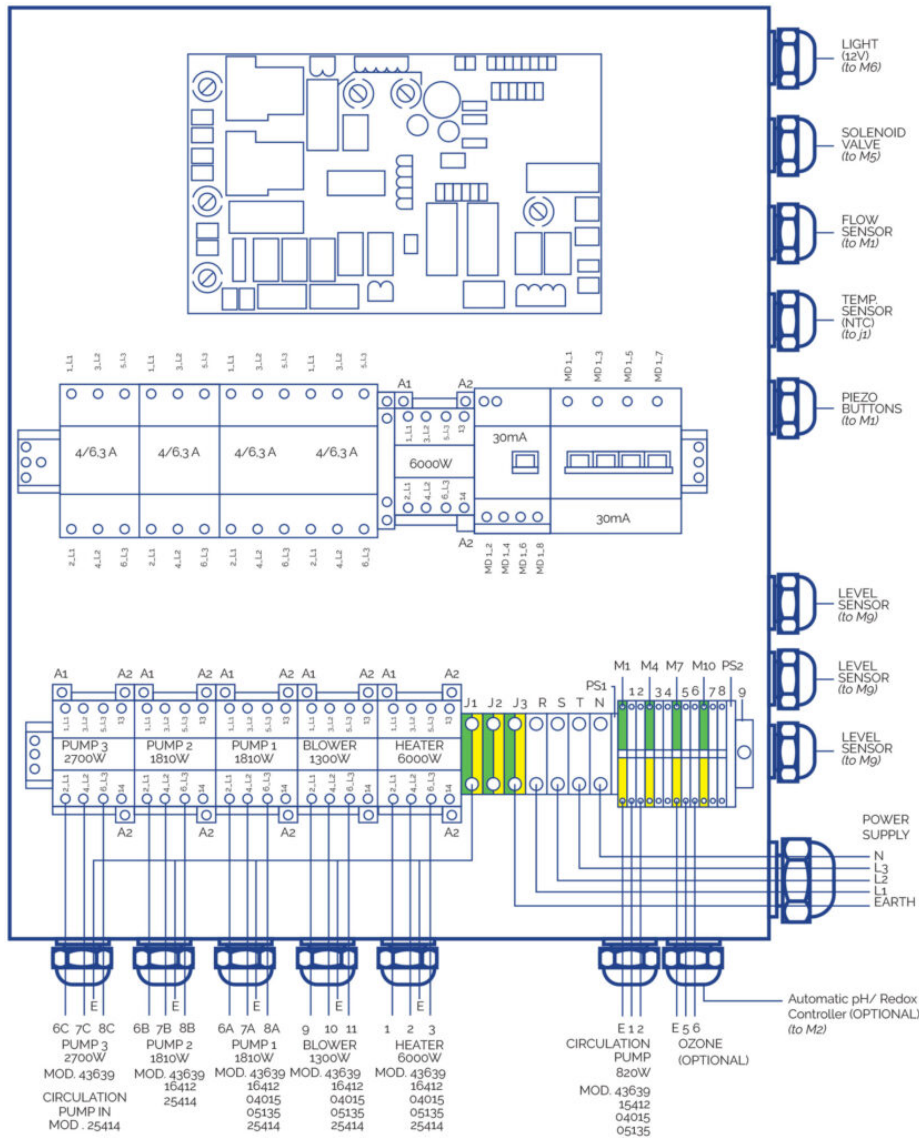

WIRING SECTIONS

Connect cables to their corresponding sections to ensure proper functioning and to prevent potential electrical problems that could affect the user's safety.

P max [W]

	20 > L [m]	20 ? L 35 [m]	35 ? L < 55 [m]
Sc [mm²]	20	35	55
0,5	882	504	321
1	1764	1008	641
1,5	2646	1512	962
2,5	4410	2520	1603
4	7055	4032	2566
6	10583	6047	3848
10	17638	10079	6414
16	28221	16126	10262

KIT 43639

A			
Element	P total [W]	P phase [W]	I phase [A]
R	6000	2000	9
P.F	820	273	1.6
P.2	1810	603	3.2
P.3	2700	900	3.2
B	1300	433	3.8
PTC	-	-	-
F	-	-	-
T	-	-	-

* Shielded cable

B						
Element	P total [W]	P fase [W]	I fase [A]	Sc [mm ²]		
				20 > L [m]	20 ? L 35 [m]	35 ? L < 55 [m]
T	-	-	-	4	6	10
N	-	-	-	4	6	10
L1-L2-L3	14463	4821	254	4	6	10

KIT 16412CE

A			
Element	P total [W]	P phase [W]	I phase [A]
R	6000	2000	9.0
P.F	820	820	3.8
P.1	1810	603	3.2
P.2	1810	603	3.2
P.3	0	0	0.0
B	1300	433	3.8
PTC	-	-	-
F	-	-	-
T	-	-	-

* Shielded cable

B						
Element	P total [W]	P phase [W]	I phase [A]	Sc [mm ²]		
				20 > L [m]	20 ? L 35 [m]	35 ? L < 55 [m]
T	-	-	-	4	6	10
N	-	-	-	4	6	10
L1-L2-L3	14463	4821	25,4	4	6	10

KIT 04015CE

A			
Element	P total [W]	P phase [W]	I phase [A]
R	6000	2000	9.0
P.F	600	600	2.7
P.1	1050	1050	4.9
P.2	0	0	0.0
B	1300	433	3.8
PTC	-	-	-
F	-	-	-
T	-	-	-
T	-	-	-

* Shielded cable

B						
Elemento	P total [W]	P fase [W]	I fase [A]	Sc [mm ²]		
				20 > L [m]	20 ? L 35 [m]	35 ? L < 55 [m]
T	-	-	-	2.5	4	6
N	-	-	-	2.5	4	6
L1-L2-L3	9012	3483	17,7	2.5	4	6

KIT 05135CE

A			
Elemento	P total [W]	P fase [W]	I fase [A]
R	6000	2000	9.0
P.F	820	820	3.8
P.1	1460	1460	6.8
P.2	0	0	0.0
P.3	0	0	0.0
B	1300	433	3.8
PTC	-	-	-
F	-	-	-
T	-	-	-

* Shielded cable

B						
Elemento	P total [W]	P fase [W]	I fase [A]	Sc [mm ²]		
				20 > L [m]	20 ? L 35 [m]	35 ? L < 55 [m]
T	-	-	-	2.5	4	10
N	-	-	-	2.5	4	10

L1-L2-L3	9642	3893	19.6	2.5	4	10
----------	------	------	------	-----	---	----

HEATER CONNECTION

The connection of the PTC sensor must be made via an own channel in order to avoid possible interferences. Connect the Heater power supply to the electrical control board as follows:

- Open the rear housing of the Heater
- Connect the following outputs with the corresponding inputs of the electric control box.
- Neutral and Ground remain free:

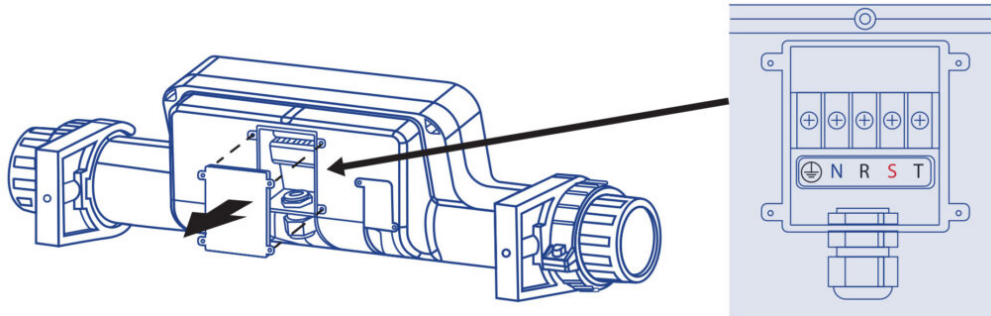

PRINTED CIRCUIT BOARD

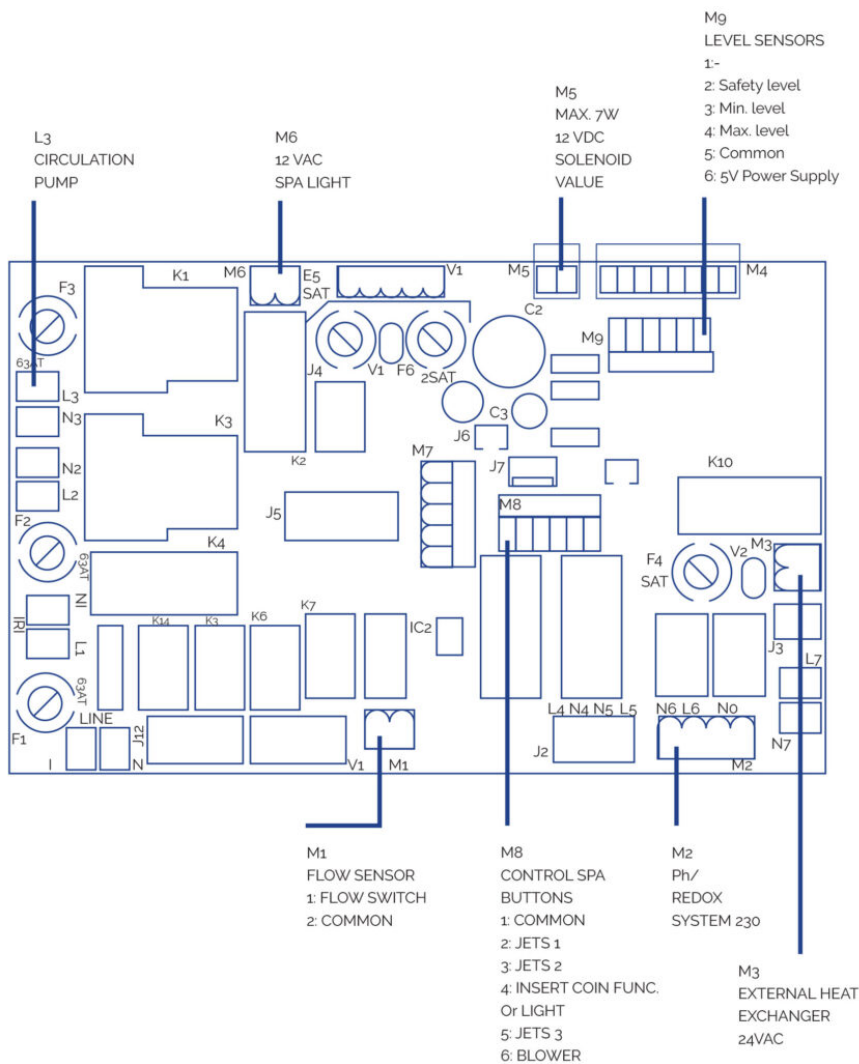

REMOTE SPA PUSH BUTTONS CONNECTION

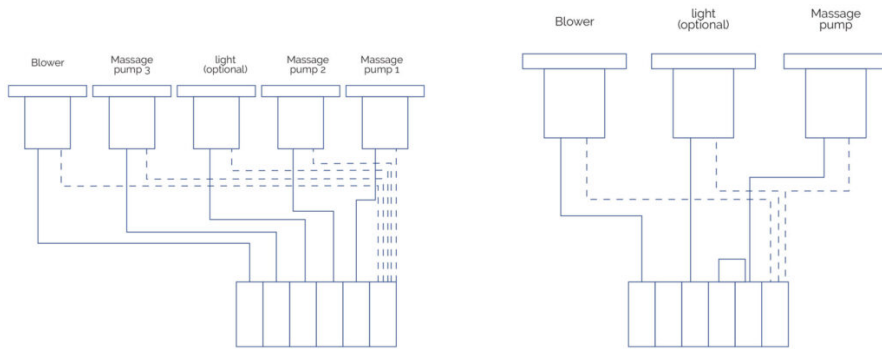

LIGHT

Connect directly to the M6 output of the PCB. Can be switched off or on from the front control panel of the electrical box.

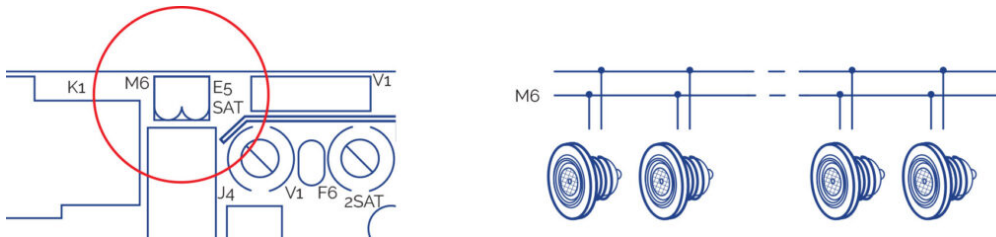

OTHER ELECTRICAL CONNECTIONS

- Connect the three level sensors supplied with the balance tank directly to the M9 input of the PCB.
- ?Connect ozone wire directly to the grid 5-6 input of the electrical box.
- Connect the electric control box to the power supply.

ATTENTION

Make sure all the hydraulic and electrical / electronical connections are done before connecting the electric control box to the power supply.

It is mandatory to use packing glands for all the connections coming out of the cabinet and the junction box, and to use terminals in all connections in order to preserve the integrity of the leads.

4.4. Hydraulic connection

The compact kit must be below the Spa level. This avoids having to prime the pumps. The maximum difference in level is 2 metres below (h ?2m).

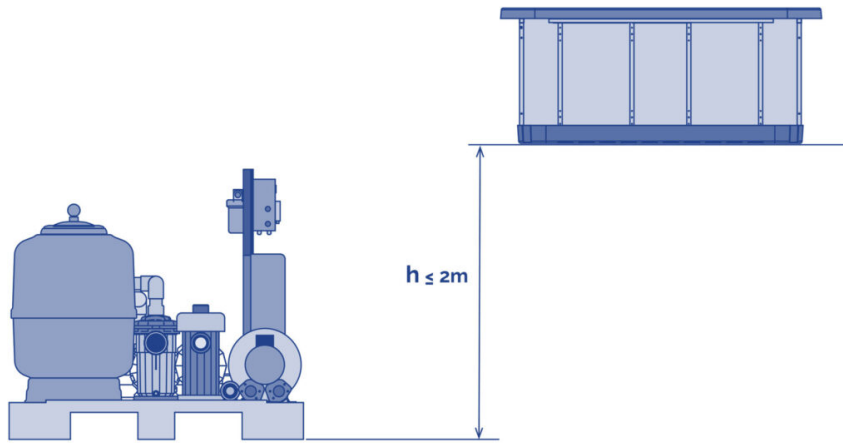

Spas with overflow have a balance tank, which has a double function:

- Absorbing the water displaced by the people who enter the Spa.
- Ensuring the filtration pump is never left without water.

To correctly install this tank, it should be placed as near as possible to the Spa, below the level of the overflow, so that the overflow can evacuate all the water.

KIT TO SPA CONNECTION

Use a hard pipe or flexible hose of an appropriate resistance. Check the regulations in force in each country.

You must use the same pipe diameter as that of the Spa's connection; these diameters are sized for optimal performance of the kit. Use the right glue for each material. In any case, it will be necessary to minimize the installation of elbow fittings and pipe length to reduce the drop of pressure in the installation.

The Spa's connections with couplings are marked with stickers indicating the circuit and the water flow direction.

Before and after each pump and on the heat exchanger outlet, place a ball or guillotine valve for carrying out maintenance or replacements on these elements.

Recirculating circuit connection

SPA WITH OVERFLOW

Spa Connection – Balance Tank

Connect the overflow pipes to the balance tank. The pipes should be sloping sufficiently to ensure the water evacuates by gravity. Under no circumstance should siphons be created that could prevent water circulation. The diameter of the pipes for collecting water from the overflow should be calculated in such a way that the water does not exceed the recommended speed by the regulations in force. Connect a drainpipe in the upper part of the balance tank; its function is to evacuate possible excess water preventing the deposit from overflowing. Connect the balance tank outlet with the filter pump suction, placing a check valve between the deposit and the pump.

The outlet will have to be placed below or at the same level as the bottom of the balance tank. Spa with overflow.

Connection between Balance Tank – Compact Kit

Connect the filter pump outlet to the filter's selector valve (depending on the kit model, this connection may already been made). Connect the selector valve outlet with the water inlet of the heat exchanger (depending on the kit model this connection may already be made). If your Spa has the ozone option, follow the instructions indicated in the Ozoniser installation sheet now.

For the selector valve connections, always use plastic accessories, gasket and Teflon tape. Under no circumstance should you use metal accessories or tubing, which could seriously damage the plastic components.

Connection between Spa – Compact Kit

If your spa has a spa floor cleaning connection; connect the floor cleaning outlet with the filter pump inlet making the connection in parallel with the other inlets to this pump. You must place a ball valve between the outlet and the pump which will normally remain closed.

- Option A Spa Floor Suction: Connect the Spa floor drain to an inlet in parallel to the filter pump. Place a ball or guillotine valve between this connections.
- Option B Spa Floor Return: No operation is required.

Connection between Compact Kit – Spa

Connect the heat exchanger with the Spa filter return sleeves.

- Option A Spa Floor Suction: Place a check valve between the exchanger outlet and the inlet to the spa.
- Option B Spa Floor Return: Connect the exchanger outlet with the Spa floor drain, in parallel with the filter return via the return nozzles.

Installation of level sensors

In order to ensure that the recirculating circuit always contains water, you must install the level sensors in the balance tank. These will control the opening and closing of a filling solenoid valve.

Look at the following diagram.

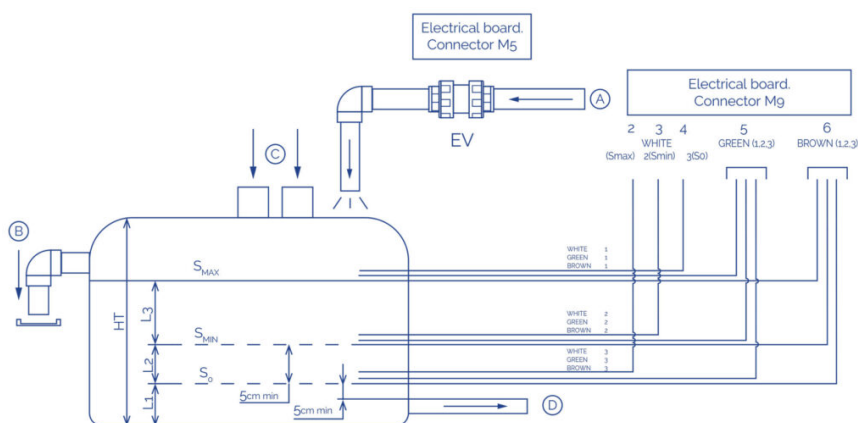

So	Safety probe	A	Network water inlet
SMIN	Mínimum level probe	B	Deposit overflow
SMAX	Maximum level probe	C	Spa overflow water inlet
EL	Electric control box	D	Water outlet towards filtration
EV	Electric valve (not included)	Ht	Total height

S0 sensor has to be placed above the bottom outlet pipe.

Smin sensor has to be placed above S0 sensor.

There must be more water than the volume displaced by all bathers between Smin and Smax. Smax has to be placed below the top drain..

The level sensors have to be attached to outer side of the balance tank.

The system will be automatically blocked when water level is below so sensor.

The electric valve (EV) will be activated (the tank will start filling) when the level drops to below SMIN and will be deactivated when it exceeds SMAX.

If you do not install level sensors, follow the next diagram.

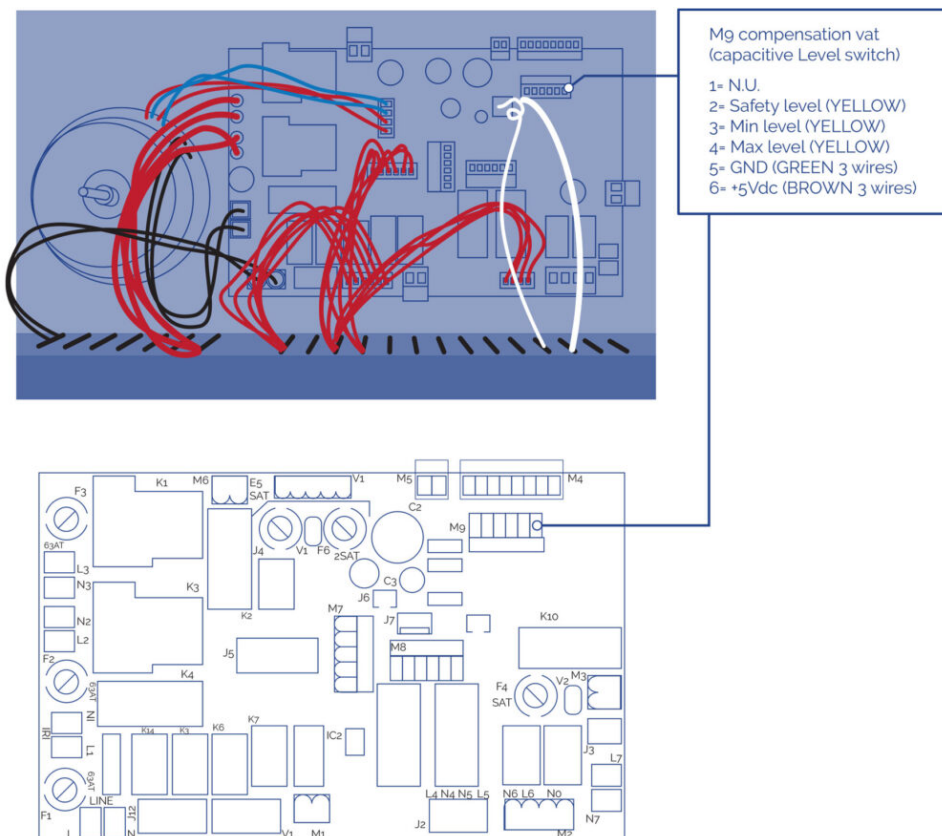

SPA WITH SKIMMER

Connection Spa - Compact Kit

- Connect the skimmer outlet with the heat exchanger inlet.
- Connect the Spa floor drain with the filtration pump inlet in parallel to the rest of the inlets.
- Connect the filtration pump outlet to the filter's selector valve (depending on the kit model,

this connection may already be made).

- Connect the selector valve outlet to the water inlet of the heat exchanger (depending on the kit model, this connection may already be made).

If your Spa has the ozone option, follow the instructions indicated in the Ozonator installation sheet now.

For the selector valve connections, always use plastic accessories, gasket and Teflon tape. Under no circumstance should you use metal accessories or tubing, which could seriously damage the plastic components.

Connection Compact Kit– Spa

Connect the heat exchanger outlet with the Spa's filter return nozzles, placing a check valve in this connection.

Water massage circuit connection

Connect the pipe to the water suction drains with the inlet to the massage pump (each pump will suction the water of 2 drains). Connect the outlet of each of the massage pumps to the connections in the Spa battery that will guide the water to the jets. Place a ball or guillotine valve in the inlet and outlet of each pump.

Air massage circuit connection

Leave the air pump inlet free and connect the pump outlet to the Spa's corresponding connection.

Note: It is essential to install a 150mm siphon above the maximum water level and to place a check valve between the siphon and the Spa.

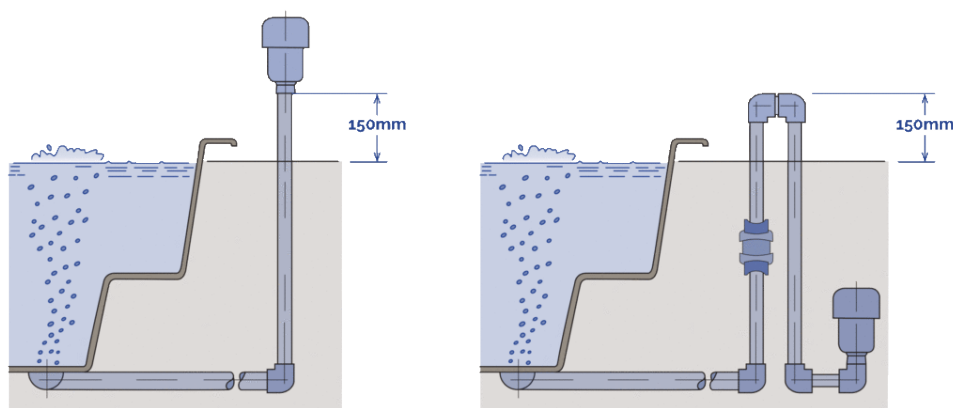

5. Operating instructions

5.1. Warnings

SAFETY WARNINGS

- Carefully check the water temperature. Do not use the water at temperatures over 40°C. Ideal temperature is 35-36°C
- ?Pregnant women, small children, persons with heart conditions, or health problems or under medical care must not use the spa without first consulting a doctor.

- Take special care if you are alone when using the spa. Prolonged immersion in warm water may cause nausea, dizziness and fainting.
- Set the spa at a lower temperature if you intend to use the spa for more than 10-15 minutes.
- Do not use the spa after drinking alcohol, taking drugs or medicines that cause drowsiness or that can raise/lower the blood pressure.
- Be especially careful when getting in and out of the spa when the floor is wet.
- Electrical appliances (radios, hair dryers etc.) must not be used near the spa.
- During use of the spa, keep your head, body and clothes at a distance of at least 40 cm from the ? suction intakes. Long hair must be tied back and secured in place.
- Do not start the spa if the protective grilles are broken or missing.
- Only use original spare parts. Any modification requires manufacturer authorisation.
- Check the level of free chlorine and pH before use. Do not use the spa if these levels are out of normal recommended ranges or if a shock treatment is in process.

USE WARNINGS

Power supply interruption

Should the power supply be interrupted, the system will always automatically restart in the operating mode it was in before the interruption.

After a power outage the filtration pump will automatically start. Make sure the hydraulic circuit is ready or connect/disconnect necessary items before starting the system.

Incompatible functions

In order to prevent possible interferences between functions the system software doesn't allow the following operations:

- When the filtration pump has been activated in manual mode it must also be manually deactivated before switching on any other pump, or the system will stop and E02 (error 02) will be shown in the main display. Push SET and MANUAL keys consecutively to deactivate the error message.
- All pumps must be switched off before switching from manual to automatic mode, or the system will stop and E02 (error 02) will be shown in the main display. Push SET and MANUAL keys consecutively to deactivate the error message.
- The filtration pump is always activated for the first 5 minutes after the system starts, and continues working until the programmed temperature is reached. The heater then shuts off and the filtration pump continues working for 5 more minutes in order to cool the heater to atmospheric temperature.
- The insert coin feature (optional) is not compatible with the light control via external button option.

RISK OF HYPERTHERMIA

- Prolonged direct contact with hot water can cause HYPERTHERMIA, which occurs when the internal temperature of our body reaches levels above the normal temperature of 36.5°C.
- Symptoms of hyperthermia include a sudden drop in blood pressure and in consequence a feeling of faintness with the possibility of fainting.
- The Spawater should never exceed 40°C.
- Water temperatures of between 37°C and 40°C are considered safe for adults who have no health problems. Lower temperatures are recommended for most people and for children.

- Remember that prolonged bathing in the Spa can cause hyperthermia.
- The use of alcohol, drugs or medication may increase the risk of hyperthermia.

5.2. Hot keys

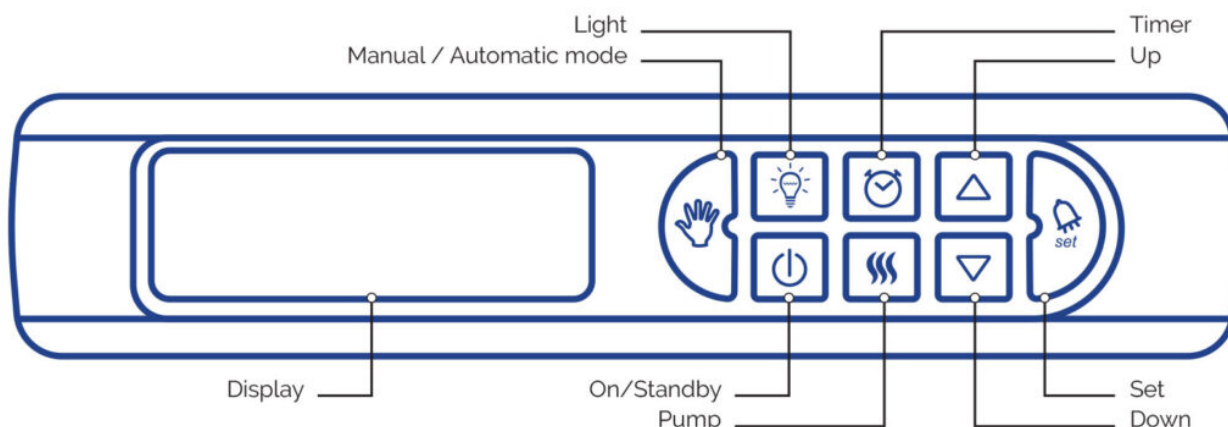

ON / STAND-BY

Turns On the system or sets to Stand by mode.

When the system is in On mode:

- The ON/STAND BY button lights up and the current spa temperature is shown in the display.
- The Spa can be controlled from the Front Panel or from the REMOTE SPA buttons, depending if the AUTOMATIC/MANUAL button is on or off (See Automatic/Manual function).
- Filtration cycles and temperature.

When the system is in STAND BY (Ecomode) mode:

- The ON/STANDBY button is not lit and the display shows the current time.
- FRONT PANEL buttons, REMOTE SPA Buttons, massage and blower pumps, light and all other buttons except ON/STANDBY button are inactive and unlit.
- Circulation pump is automatically activated every 30 seconds.
- Heater is automatically activated for keeping programmed (set point) temperature.
- Anti-stagnation function Active (see System Fixed Features).
- Anti-freeze function Active (see System Fixed Features).

UP AND DOWN

Increase and decrease a certain value or activate and deactivate the component shown in the display.

- When this option is enabled the buttons UP and DOWN light up.
- Only works when the system is in ON mode.

LIGHT

Turns on or turns off the spa light.

- The LIGHT button lights up when the spa light is turned on.

MANUAL / AUTOMATIC

- Turns the system from automatic to manual mode.
- When the system is in MANUAL mode the MANUAL/AUTOMATIC button lights up and the REMOTE SPA buttons are inactive. The system can only be operated from the front panel keyboard.
- MANUAL mode allows time and filtration cycle setting, temperature setting, pumps manual activation and deactivation, filter backwashing, and units and massage setting.
- When the system is in Manual mode, if the heater or a filtration cycle are running they stop until the system returns to automatic mode.

FILTRATION CYCLE TIMER

- Use this button to access the filtering cycle program menu.
- The system includes a default filtration cycle that can be reprogrammed.
- The system must be in MANUAL mode to temporarily interrupt the filtering cycle and manually operate the filtration pump.
- To change the system time and program the filter cycle press the FILTRATION CYCLE TIMER button for 3 seconds. See Time and Filtration Cycle Setting Menu.
- When programming is in process the button lights up.
- If a filtration cycle is running the button flashes.
- If the filtration cycle is not running or the system is in MANUAL mode the button light is off.
- When massage or blower pumps are active the system automatically starts the circulation pump even if the programmed filtration cycle is not running.

PUMP

Use this button to manually start or stop the pumps.

- Activates and deactivates massage, circulation and blower pumps when the system is in MANUAL mode.
- If a pump is running in either AUTOMATIC or MANUAL mode the button lights up.

SYSTEM SETTING / ENTER KEY

- Press this button for 3 seconds when the system is in MANUAL mode to change to CONFIGURATION MODE (Units and Massage Settings Menu). Massage, massage inhibition and temperature settings can be configured.
- The button lights up when setting is in process.
- When a configuration program is in progress press once shortly to confirm an entry and starts the desired process.
- At least one alarm is active if the button is flashing. Read the display to see which alarm needs to be checked.

5.3. Configuration menus

TIME AND FILTRATION CYCLE SETTING

When the system is in MANUAL mode, press  for 3 seconds to start the Time and Filtration Cycle Menu.

- The 1st parameter (T1) appears in the display.

Press up and down buttons   to set the hour (2 digits).



Press  to confirm.

- The 2nd parameter (T2) appears in the display.

Press up and down buttons   to set the minutes (2digits).



Press  to confirm.

- The 3rd parameter (C1) appears in the display.



Press up and down buttons   to set what time the filtration cycle starts (2 digits). Hourly only.

Press  to confirm.

- The 4th parameter (C2) appears in the display.

Press up and down buttons   to set what time the filtration cycle ends (2 digits). Hourly only.

Press  to confirm.

- C1 and C2 fields refer to hours, not minutes.
- If C1 = C2 the circulation pump is always running.
- Press  or  or wait 10 seconds to exit Time and Filtration Cycle Setting Menu.

PUMPS MANUAL CONTROL MENU. FILTER BACK WASHING

- The system can control up to 5 pumps: 1 filtration pump, 1 to 3 massage pumps, and 1 blower.
- When the system is in MANUAL mode press  and the 1st parameter, PF (Filtration Pump), will be shown in the display.

Pressing  the PF value turns to ON and pressing  the PF value turns to OFF.

- Press  again and the 2nd parameter, BL Blower, will be shown in the display.

Pressing  the BL value turns to ON and pressing  the BL value turns to OFF.



- Press  again and the 3rd parameter, P1 (Massage pump 1), will be shown in the display.

Pressing  the P1 value turns to ON and pressing  the P1 value turns to OFF.

- Press again  and the 4th parameter, P2 (If installed, Massage pump 2), will be shown in the display.

Pressing  the P2 value turns to ON and pressing  the P2 value turns to OFF.

- Press  again and the 5th parameter, P3 (If installed, Massage pump 3), will be shown in the display.

Pressing  the P3 value turns to ON and pressing  the P3 value turns to OFF.

- Press  to exit MANUAL mode and the system will turn to AUTOMATIC mode.

To simplify the technical assistance and electronic management all systems have the same version of software. The System always shows 3 massage pumps that can be virtually operated even if they are not physically installed .

According to European safety regulations, the system will automatically activate the filtration pump when a massage or blower pump is in use.

Manual Pumps Activation

Parameter	Description	Value	Default value	Involved Function
PF	Filtration Pump	ON/OFF	OFF	Filtration / Backwashing
BL	On/Off Blower	ON/OFF	OFF	Air massage
P1	On/Off Pump 1	ON/OFF	OFF	Water massage
P2	On/Off Pump 2	ON/OFF	OFF	Water massage
P3	On/Off Pump 3	ON/OFF	OFF	Water massage

DAILY WATER REPLACEMENT FUNCTION

Legislation requires that public use spas guarantee that a percentage of spa water is replaced daily. The replacement rate will depend on the legislation in force in each country.

This system opens the solenoid fill valve daily for a certain period of time (which can be set by the customer according to the diameter and pressure of the fill system).

The water replacement function takes into account the amount of time the solenoid fill valve is open for maintenance and/or auto-fill functions, subtracting this amount of time from that programmed by the customer.





The water replacement function will still run even if the circuit is filled to the surge tank's maximum level.

Manual drainage is required should the circuit require draining due to excess water in the surge tank.

TEMPERATURE

- Current Spa temperature is shown in the display when the system is in ON mode.

ON / STANDBY button  lights up.

- Press  or  once the programmed temperature (Set Point) is shown in the display.
- Continue pressing  or  the programmed temperature (SP) will go up or down.

- When the temperature will be in the desired value stop pressing. The system memorizes the value automatically.
- Default spa temperature is 36°C.
- If the power supply is interrupted, the programmed temperature (Set Point) value returns to the last Set Point programmed.



Temperature program



Parameter	Description	Interval	Default value	Involved Function
SP	Programmed temperature	15-40 (°C)	36 (°C)	Heating
		59-104 (°F)	97 (°F)	



Temperature unit can be changed in the UNITS AND MESSAGE SETTING MENU.

UNITS AND MESSAGE



- When the system is in MANUAL mode Press  for 3 seconds and the system displays the UNITS AND MESSAGE SETTING MENU.
- The 1st parameter, Un (Unit of temperature) will be shown in the display.

Pressing  the system will turn to Fahrenheit and pressing  the system will turn to Celsius. Default unit is Celsius.

- Press  to confirm.
- The 2nd parameter, d1 (Duration of massage) will be shown in the display.
- Press  to confirm.

Pressing   the duration of the massage can be increased or decreased. Default value is 10 minutes. The measurement unit is the minute.

- Press  to confirm.
- The 3rd parameter, d2 (Inhibition time) will be shown in the display. Controls how long the button that activates the pump is idle after finishing the massage cycle.

Pressing   you can choose the massage inhibition time. The default value is 00 seconds. The measurement unit is the second.

- Press  to confirm.
- Press  or  or wait 10 seconds to exit the System Setup Menu.

General Parameter Configuration

Parameter	Description	Interval	Default value	Involved Function
Un	Temperature units	°C - °F	°C	Temperature

d1	Massage duration time	00-99(minutes)	10 minutes	Water/Air massage
d2	Massage inhibition time	00-99 (seconds)	00 seconds	Water/Air massage
rn	Nr refill	0-2 (s)	0	Ev load
d3	Refill duration time	00 - 99 (m)	0	Ev load

LIGHT CONTROL

Light is controlled by the LIGHT  button and/or the spa push button (optional).

5.4. Remote control (Spa buttons)

The pumps can be activated from the spa if the appropriate switches are installed. Each switch can control one or more pumps at once. Depending on the system's configuration.

- By pressing the corresponding switch the pump begins to operate and does not stop until the time programmed in parameter d1 (Units and Massage Setting Menu) is completed or the switch is pressed again.
- If the parameter d2 has been programmed with a value greater than 0 the pump may not be activated until this time has elapsed.
- Massage and inhibition time are independent for each switch.

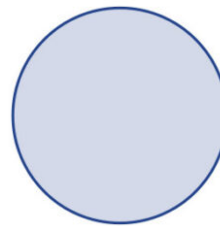
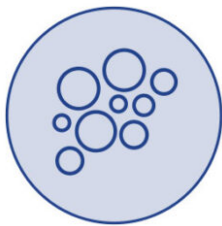

Air massage pump(s) remote activation
 Water massage pump(s) remote activation
 Light (option)

5.5. System fixed features

This System has configured default parameters that can not be changed by the user.

HEATER ACTIVATION

The heater will start/stop when the real temperature has a deviation of more than 1°C compared to the scheduled one. (Hysteresis value). The system checks water temperature automatically every 30 minutes

ANTI-STAGNATION SYSTEM

If the massage function has not been activated for more than 12 hours the system will automatically switch on massage and blower pumps for 30 minutes to prevent possible water stagnation.

OZONATOR

The ozonator (optional device) is active for 20 minutes and inactive for 10 minutes when the filtration pump is working.

It is disabled if a massage or a blower pump is active except when these pumps have been activated automatically by the system (Anti-stagnation system every 12 hours).

ANTI-FREEZING

In order to avoid cool external temperatures from freezing the water inside the hydraulic circuit, massage and circulation pumps will be automatically switched on for 30 min. if the water temperature is between 5 and 9°C and pumps are inactive for more than 60 min.

If the water temperature is less than 5°C, pumps will be activated until the water temperature reaches at least 5°C.

Water temperature (°C)	Activation time (minutes)
5-9	30
<5	Continuous

AUTO-FILL

The system includes automatic filling through the surge tank. This system ensures that the spa water has been filtered before reaching the spa.

This system is only active in manual mode.



To use the auto-fill to fill the spa, ensure that the solenoid fill valve is connected to a water supply and that all valves are opened properly. Switch the system to MANUAL mode (see 5.3.4. to set up in MANUAL mode).

The system will fill the entire hydraulic circuit.

Errors E1 and E11 will appear while the spa is filling for informative purposes. Once the entire circuit is filled (spa, filter and tank), press the SET button and put the system in MANUAL mode to delete the error messages.

DAY WATER REPLACEMENT



This system opens the solenoid fill valve in order to replace water once or twice a day for a maximum of 99 minutes each time the system runs, so that a maximum of 198 minutes can be programmed daily.

- Press  for 3 seconds when the system is in MANUAL mode and the PARAMETER SETUP MENU will appear.
- The first parameter, Un (Unit of temperature), will appear on the screen
- Press  3 times and the r n parameter will appear:





o r n = 0 -> system deactivated

o r n = 1 -> only once a day, the solenoid valve will open at 6:00 a.m.

o r n = 2 -> twice a day, the solenoid valve will open at 6:00 a.m. and 6:00 p.m.

- Press  or  to change the r n value.

Note: The user may not change the times the solenoid valve is opened.

- Press  to confirm and the d3 parameter will appear:
- Press  or  to change and program how long the valve is open (0 to 99 minutes).
- Press  to confirm.

General Parameter Configuration

Parameter	Description	Interval	Default value	Involved Function
Un	Temperautre units	°C - °F	°C	Temperature
d1	Massage duration time	00-99 (minutes)	10 minutes	Water/Air massage
d2	Massage inhibition time	00-99 (seconds)	00 seconds	Water/Air massage
m	Nr refill	0-2 (s)	0	Ev load
d3	Refill duration time	00-99 (m)	0	Ev load

5.6. Optional functions

The features explained in this manual correspond to standard configuration. These optional functions can be configured from a hidden menu. If you are interested please contact your dealer.

- Insert coin option (or light control via external button)
- External heat exchanger

6. Maintenance

6.1. Maintenance warnings

- Before proceeding to carry out any electrical or mechanical intervention, please ensure the machine is disconnected from the power supply network and that the start up devices are blocked.
- Do not handle the equipment with wet feet.

6.2. Acrylic maintenance

Easy care for an elegant surface:

- Use common cleaners for general use. For normal care and cleaning, use a soft cloth or sponge with a little soap and water. Rinse it well, and dry with a clean, dry cloth. If you are using a household cleaner, please ensure it is recommended for acrylic surfaces by the manufacturer.
- Never use abrasive cleaners.
- Do not allow the acrylic surface to come into contact with ketones or esters such as acetone, acetates (such as nail varnish remover, nail varnish or dry cleaning substances) or any

- organic solvent with chlorine, varnishes, petrol, aromatic solvents, etc.
- Remove dust, smears and dry dirt with a soft, moist cloth.
- Clean off grease, oil, paint and ink stains with isopropyl alcohol and dry it with a clean, dry cloth.
- Avoid using razors or any other kind of sharp instrument that could scratch the surface. Small scratches can be removed by applying a fine layer of automotive varnish and lightly polishing it with a clean cloth.

Once a week, clean the area of the Spa which is not underwater with a quality polish for Spas.

ATTENTION

Remember to never leave the Spa uncovered, empty and exposed to the sun, as it could cause damages that the warranty does not cover.

6.3. Maintenance in periods of non-use or absence

SHORT PERIODS (3-5 days)

- Adjust the pH and treat the water (see Water Maintenance section).
- Cover the spa.
- Before using the Spa again, readjust the pH and treat the water again.

PROLONGED PERIODS (5-14 days)

- Set the temperature at its lowest level.
- Adjust the pH and treat the water (see Water Maintenance section).
- Cover the Spa.
- Before using the Spa again, reset the temperature as required , readjust the pH and treat the water again.

PREPARTING FOR THE WINTER PERIOD

If it is not planned to use the Spa through the winter season or for prolonged periods of time, the following operations should be done:

- Disconnect the electrical equipment.
- Empty the water from the Spa.
- Leave the drain valve open.
- Clean and dry the Spa.
- Cover the Spa.

You should not leave water in the Spa without an electrical connection outdoors in temperatures below 0°C, given that the pipes could freeze and damage the Spa.

It is necessary to comply with Regulations in force in each country regarding Legionella. All responsibility for compliance with these falls on the owner of the Spa.

6.4. Water maintenance

Water maintenance is one of the areas where the user should provide greatest attention, given its importance. This maintenance will depend on the mineral content of the water used, of the Spa's frequency of use, and of the number of people using the Spa.

There are three main points to take into account in water maintenance:

- WATER FILTRATION
- CHEMICAL ANALYSIS AND PH CONTROL
- DISINFECTION OF THE WATER

7. Error codes

The following table summarizes the error codes the display shows to the operator and the related description.

Type	Description	Cause	Solution
E01	Safety level of balance tank not reached. Autoresettable.	The Safety level sensor of the balance tank doesn't detect water. No function can be activated.	Fill the balance tank until minimum sensor level.
E02	Water flow or temperature failure. Automatically self-operational alarm Autoresettable.	Flow sensor doesn't detect water flow or temperature sensor doesn't send any signal. No function can be activated.	Check possible obstructions in the filtering circuit, pumps, or filter. Check possible sensor malfunction.
E04	Water temperature is too high. Automatically self-operational alarm Autoresettable.	The water temperature inside the Spa is over 42°C. No function can be activated	Let the water cool or add cool water. When the temperature will be below 42°C your SPA will start up automatically; if not unplug the power supply and contact your dealer.
E05	Water temperature sensor. Autoresettable.	The temperature sensor is malfunctioning. No function can be activated.	Check the water temperature and temperature sensor and replace it if needed.

E07 E08	Heater contactors. Not Autoresettable.	The heater contactors are malfunctioning; you cannot activate the electrical heater.	For safety reasons, the electric heater is powered by two contactors, which are serially connected; if one of these two contactors is stuck, an error message will appear. Replace corresponding contactors and plug the elements again.
E09	Max. time of the balance tank water filling exceeded. Not Autoresettable.	The max opening time (30') of the loading electrovalve of the balance tank has been reached	Make sure that the sensors of water level of the balance tank work properly. Make sure that the discharge hole has been left open. Check a possible water leakage in the hydraulic circuit.
E010	Balance Tank Water levels signals are incompatibles. Autoresettable.	Water level sensors are sending incompatible signals.	Check position of the level sensors or replace them if they are malfunctioning.
E011	Water level in the balance tank is below safety sensor. Autoresettable.	Some function is trying to be activated before the minimum level inside the balance tank has been reached (or when working, the level is below the safety sensor).	Make sure that the loading electrovalve is open and works properly. Make sure there's no obstruction in the water charging circuit. Verify there's no water leakage in the hydraulic circuit.
E0 Cn	Communication between Panel Control Board and local keypad.	Communication between Panel Control Board and local keypad is lost.	Make sure that the cable between the local keypad and the Panel Control Board is connected properly. If it is, unplug the system from the mains and get in touch with your dealer.

8. Evidence of conformity



IBERSPA, S.L.
Pol. Ind
Av. Pla d'Urgell 2-8
25200 - Cervera, Lleida
(Spain)

ES PRODUCTOS:
EN PRODUCTS:
DE PRODUKTE:
FR PRODUITS:
IT PRODOTTI:
PT PRODUTOS:
NL PRODUKTEN:
RU продукт:

DA PRODUKTER:
S PRODUKTER:
FI TOUTTEET:
N PRODUKTER:
GR ΤΠΟΝΤΑ:
PL PRODUCTY:

PUBLIC SPAS
PUBLIC COMPACT KITS

ES - DECLARACION DE CONFORMIDAD

Los productos arriba mencionados se hallan conformes a : Directiva 2014/30/UE (Compatibilidad Electromagnética), Directiva 2014/35/UE (Baja Tensión) y la Norma Europea EN 60335-2-41

DA - FÖRSÄKRAM OM ÖVERENSSTÄMMELSE

Ovans ende produkter ä i överensstämmelse med : Direktiv 2014/30/UE (Elektromagnetisk kompatibilitet), Direktiv 2014/35/UE (L gspänning) och med Europeisk Standard EN 60335-2-41

EN - EVIDENCE OF CONFORMITY

The products listed above are in compliance with : 2014/30/UE (Electromagnetic Compatibility), Directive 2014/35/EU (Low Voltage) and with the European Standard EN 60335-2-41

S - ÖVERENSSTEMMELESESERKL RING

Ovenst ende produkter oppfyller betingelsene elektromagnetiskdirektiv 2014/30/UE , lavpenningsdirektiv 2014/35/UE . og Europeisk Standard EN 60335-2-41

DE - KONFORMITÄTSEKTLÄRUNG

Die oben angeführten Produkte entsprechen den, Sicherheitsbestimmungen der Richtlinien der Elektromagnetischen Verträglich 2014/30/UE , der Niederspannungs Richtlinien 2014/35/UE , un der europäischen Vorschrift EN 60335-2-41

FI - ÖVERENSSTEMMELESESERK RING

De ovenn vrte varer er i överensstemmelse med : Direktiv- 2014/30/UE (Elektromagnetisk forenelighed), Direktiv- 2014/35/UE (Lavsp nding) og i överensstemmelse med den europ iske standard EN 60335-2-41

FR - DECLARATION CONFORMITÉ

Les produits mentionnés ci-dessus sont conformes aux : Directive Compatibilité Electromagnétique 2014/30/UE , Directive Basse Tension 2014/35/UE et à la Norme Européenne EN 60335-2-41

N - VAKUUTUS YHDENMUKAISUDESTA

Yllämainiut tuotteet ovat yhdenmukaisia direktiivin 2014/30/UE (Elektromagneettinen yhdenmukaisuus), direktiivin 2014/35/UE (Matalajännite)sekä eurooppalaisen standarin EN 60335-2-41

IT - DICHIARAZIONE DI CONFORMITÀ

I prodotti su elencati sono conformi alle seguenti : Directiva 2014/30/UE (Compatibilità elettromagnetica), Directiva 2014/35/UE (Bassa Tensione) e alla Norma Europea EN 60335-2-41

GR - ΑΗΛΩΣΗ ΣΥΜΒΑΤΟΤΗΤΑΣ

Τα παραπάνω προϊόντα είναι σύμφωνα με την Οδηγία 2014/30/EE , (Ηλεκτρομαγνητική Συμβατότητα) την Οδηγία 2014/35/EE (Χαμηλής Τάσης) και ε τον Ευρωπαϊκό Κανονισμό EN 60335-2-41

PT - DECLARAÇÃO DE CONFORMIDADE

Os produtos acima mencionado estão conforme a : Directiva 2014/30/UE (Compatibilidade Electromagnética), Directiva 2014/35/UE (Baixa tensão) e a Norma Europeia EN 60335-2-41

PL - DEKLARACJA ZGODNOŚCI

Wymienione powyżej produkty są zgodne z: Dyrektywą 2014/30/UE (Kompatybilność Elektromagnetyczna), Dyrektywą 2014/35/UE (Niskie Napięcie) oraz Norma Europejska: EN 60335-2-41

NL - CONFOMITEITSVERKLARING

Bovenstaande produkten voldoen aan de veiligheidsvoorschriften van de Richtlijn Electromagnetische compatibiliteit 2014/30/UE , laagspannings richtlijn 2014/35/UE en aan de Europese norm EN 60335-2-41

RU - ДЕКЛАРАЦИЯ СООТВЕТСТВИЯ

Упомянутые выше модели соответствуют: Директиве 2014/30 / EC (об электромагнитной совместимости), Директиве 2014/35 / EC (о низком напряжении) и Европейском стандарте: EN 60335-2-41

Firma/Cargo:

Signature/Qualification:

Unterschrift/Qualifizierung:

Signature/Qualification:

Firma/Qualifica:

Assinatura/Título:

Handtekening/Hoedanigheld:

подпись / квалификация:

Namnteckning/Befattning:

Underskrift / Stilling:

Signatur/Tilstand:

Allekirjoitus/Virka-asema:

Υπογραφή/Θεση:

Podpisu/Stanowisko:

Gerente de Iberspa, S.L. PP
Manager of Iberspa, S.L. by proxy

© Iberspa, 2024