

# **User operation & installation manual Hotel Spa**

**English**

# Contenido

1. Introduction
2. General warnings
3. Installation and assembly
  - 3.1. Warnings
  - 3.2. Position and location of the spa
  - 3.3. Description of the installation
  - 3.4. Drainage
  - 3.5. Filling the spa
  - 3.6. Electrical connections
4. Start-up
5. Operating instructions
  - 5.1. Warnings on the use of the spa
  - 5.2. Systems
    - 5.2.1. System start-up for Touch Panel
    - 5.2.2. Control system for Touch Panel
  - 5.3. Jets operation
  - 5.4. Level sensors
  - 5.5. Extras
6. Maintenance
  - 6.1. Warnings
  - 6.2. Water maintenance
  - 6.3. Filter maintenance
  - 6.4. Pre-filter of the pump maintenance
  - 6.5. Filter maintenance
  - 6.6. Light maintenance
  - 6.7. Maintenance in periods of non-use or absence
  - 6.8. Cover maintenance
7. Error codes
8. Troubleshooting
9. Recycling and the environment
10. Evidence of conformity

# 1. Introduction

This manual contains all the information needed to fully enjoy your SPA. We recommend that you take some time to go over the points detailed below.

If you have any question or doubt on the operation or maintenance of this product, please contact your fitter or local dealer. They are specialists and their professional knowledge will help you to enjoy this product.

**IMPORTANT:** The manufacturer reserves the right to change the design or specifications without prior notice and without entering any obligation.

This Spa has been designed and conceived for private use only: any public use shall annul its guarantee.

## 2. General warnings

- Carefully follow current regulations regarding accident prevention and respect regulations in each country.
- Any modification on the equipment requires prior authorisation from the manufacturer. Original spare parts and accessories authorised by the manufacturer guarantee greater safety. The manufacturer of the equipment is exempt from all liability for damages caused by using non-authorised spare parts or accessories.
- The manufacturer shall not be responsible for the damages caused by the assembly of nonauthorized accessories, nor for those caused by an improper handling by nonqualified personnel. Please contact your authorised dealer or technical assistance service if you have any doubts or need technical assistance.
- The equipment should be installed in a place which has been properly prepared and where all components of the Spa can be easily accessed. The guarantee does not cover work needed to be carried out to install or replace the product. (See the Guarantee).
- The user shall ensure that qualified adult professionals carry out both the assembly and maintenance works, who have previously carefully read the installation and service instructions.
- Contact the Technical Service of the manufacturer or your local dealer in the event of malfunction or a breakdown.
- The installation of the Spa must always meet current regulations applicable in each country, particularly those referring to electrical safety.
- This unit must be installed in an appropriately prepared area with easy access to all the components of the Spa. The Guarantee does not cover any building work required to position or replace the product. (See the Guarantee).
- The floor must be capable of supporting the expected load.
- During operation, some parts of the equipment are at dangerous electrical voltage levels. Work on each element or equipment can only be performed once it has been disconnected from the mains and with the start-up devices disconnected.
- Safety in the operation of the machine can only be guaranteed if installation and service instructions are followed.
- There is a risk of flooding with this equipment and therefore, the Spa should be installed in an area prepared to collect or drain leaking water (either from below or overflowing water) because of using the Spa or from possible leakage in any of its circuits. (See the Guarantee).

- Carefully follow current regulations regarding accident prevention.
- This appliance can be used by children aged from 8 years and above and persons with reduced physical, sensory, or mental capabilities or lack of experience and knowledge if they have been given supervision or instruction concerning use of the appliance in a safe way and understand the hazards involved.
- Children shall not play with the appliance.
- Cleaning and user maintenance shall not be made by children without supervision.
- The limits indicated on the electrical control panel cannot be exceeded under any circumstances.
- Avoid contact with electrical voltage.
- The appliance should be supplied through a residual current device (RCD) with a rated tripping current not exceeding 30 mA.
- In case you use a cover that does not have fastening and/or safety elements for preventing unsupervised access to your spa, it is recommended that you install an alternative element (e.g., access control system, fence, etc.) to prevent the unauthorised access to and use of your spa.
- The spa cover should always be kept on to reduce heat loss between uses (not during use).
- For safety reasons, only accessories supplied by the spa manufacturer should be used.
- It is recommended that experts and/or local authorities be consulted for the application of local or national laws and regulations regarding childproof fencing, safety barriers, lighting and other safety requirements.

### **ATTENTION**

Correct earthing connection is essential. The earth connection circuit of the building must be in perfect condition to guarantee the safety of the Spa user. If you have doubts on the matter, ensure the earth circuit is reviewed by qualified personnel. The manufacturer shall not be responsible for the damages caused by inadequate maintenance of the ground connection circuit. It is essential that the owner of the Spa tests the Residual Current Device (RCD) at least once a month, to check its good working order. 

### **WARNING – RISK OF INJURY**

The spa's suction devices are sized to match the specific water flow from the pump. If any of these items need to be replaced, check that the flow rates are compatible.

Never operate the spa if the suction devices are broken or missing. Never replace a suction device with one that has a lower flow rate than the original. 

### **SAFETY SIGNS (NOT SUPPLIED)**

Place permanently the safety and warning symbols on the spa or within 2 meters of it in a clearly visible location.

a) Keep children under supervision in the aquatic environment



c) Read the instruction manual/ booklet



b) No diving



d) Do not put finger into the nozzle of a hydromassage



## **3. Installation and assembly**

### **3.1. Warnings**

During the electrical connection with the equipment have special care in the layout of the cables in the bypass box, make sure no pieces of cables are in the box after closing and that the ground connexion is correctly done. Pay special care that no water enters in contact neither with the pumps neither with the electrical parts under tension.

To ensure the safety/comfort of the bather and to preserve the construction and/ or decoration materials present in the spa installation site, proper indoor air treatment (ventilation and dehumidification) is recommended.

Be careful not to install the spa on carpeting or other flooring materials (e.g., untreated cork, wood, or other porous materials) that are susceptible to moisture and bacteria, or that may be affected by chemicals used for spa water treatment.

It should be possible to remove the spa from the location where it is installed without destroying part of the built structure.

### **3.2. Position and location of the spa**

Before installing and assembling the Spa, ensure that the packaging of the Spa is in perfect condition. Contact your distributor immediately if the packaging is damaged.

Position the Spa horizontally, placing the whole base of the unit on a smooth, flat and level surface, capable of supporting the weight when used (full of water, plus the weight of the bathers).

The Spa cannot be placed on a curved surface or on blocks.

Some of the requirements for the floor under and around the spa must be considered, such as: firmness, water resistance, non-slip surface, maximum slope, horizontality, homogeneity, and surface free of sharp objects, among others.

Anchoring and support equipment is required to avoid damage due to misalignment.

There is a requirement that the supporting materials must be of sufficient strength to withstand the maximum design load of the spa, spa water, bathers, all appurtenances and elements (e.g., a gazebo). It is recommended that a qualified contractor or structural engineer be consulted to verify this requirement, even when the spa is installed on a suspended floor (balcony, deck or decking).

It is important to note the minimum clearance around the entire spa for any electrical devices or supplies (e.g., electrical outlets) in accordance with applicable regulations.

The side where the motors are located should be fully accessible. In order to carry out maintenance tasks, the location of the Spa should enable it to be moved so that all its sides can be easily accessed.

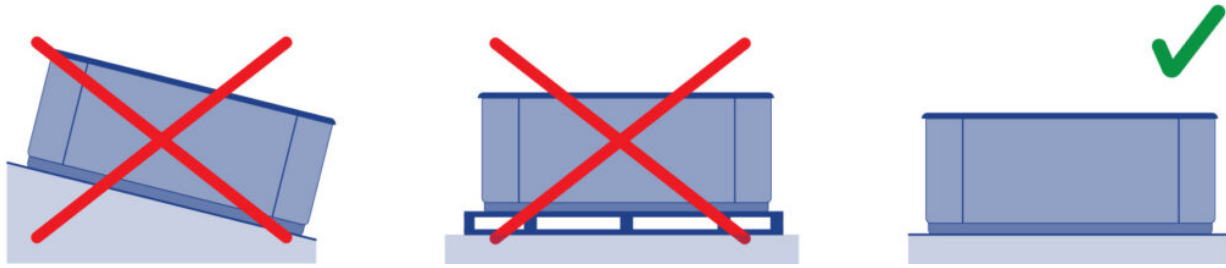

Environmental conditions, such as groundwater and frost risk, must be taken into account. Professional installers should inform the customer of these conditions.

For portable above-ground spas without floor insulation, consideration should be given to the use of an insulating liner under the spa to reduce heat loss through the bottom of the spa.

## OUTDOOR INSTALLATION

If an outdoor location is chosen to place the Spa: Do not expose the Spa to sunlight when it is empty and without a protection cover. Remember that prolonged exposure to sunlight may damage the surface of the Spa and its accessories. Acrylic rapidly absorbs heat from the sunrays reaching very high temperatures which will damage the Spa. Maximum absorption temperature is 60°C.

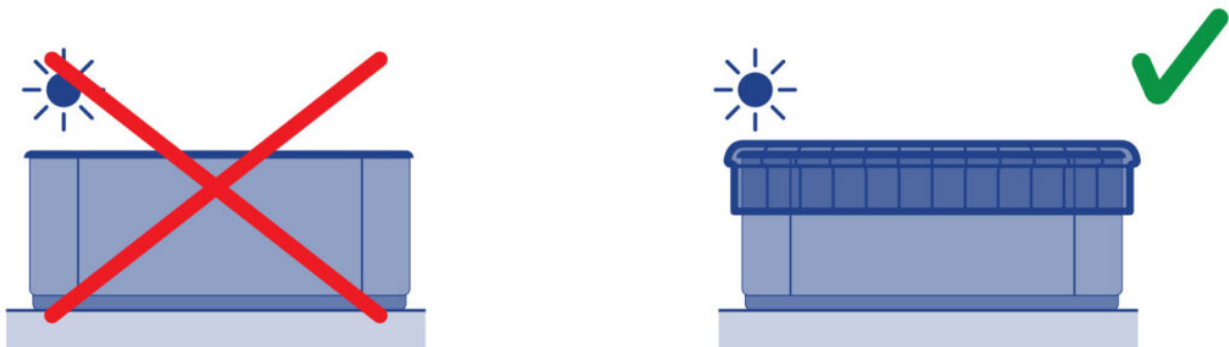

It is recommended to place the Spa away from trees, as falling leaves may block the filter.

If the Spa is placed inside glass structures, prevent sunrays shining directly on the Spa through the glass, as the temperature could be excessively hot.

## INDOOR INSTALLATION

It is recommended to ensure drainage in the area of the Spa, to prevent water from accumulating around it and to avoid dangerous access areas for bathers.

Remember that the operation of the Spa causes increased damp and therefore, there must be a ventilation system to prevent damp from accumulating which could cause damage in the room where the Spa is located.

The use of a cover reduces heat loss and damp in the room.

### ATTENTION

The spa should not be left empty and uncovered at room temperatures over 20°C or below 4°C.

It is recommended to take into account local regulations when indoor installing.

## INGROUND VERSION

The Spa structure must be fixed on the floor. Do not hold the Spa by its outer edges.

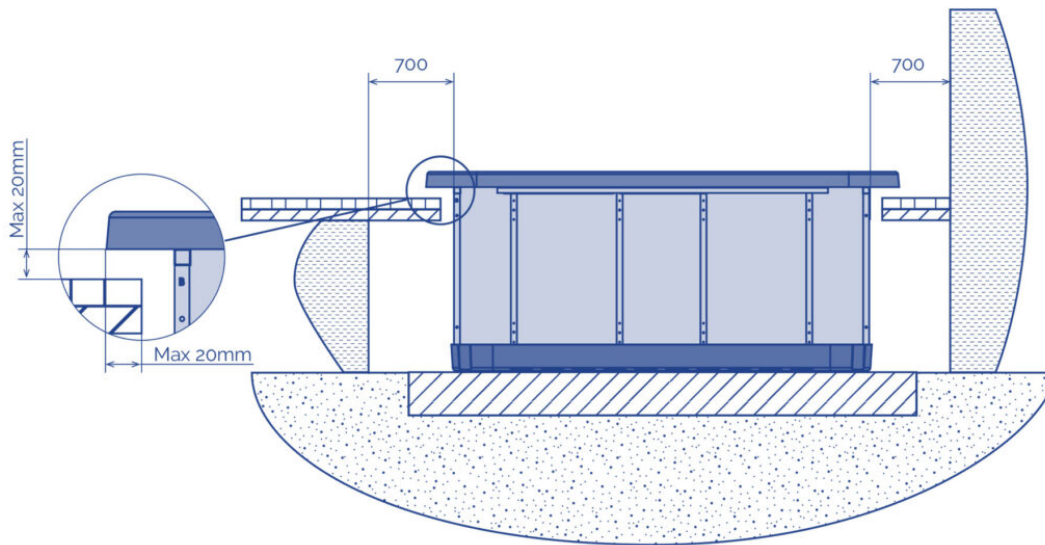

Once settled the Spa, finish the work bearing in mind that the edging of the surface must not be in direct contact with the work (a minimum of 1 cm must be left around the edge).

Bear in mind that you will have to leave enough space around the spa for maintenance. This space should be at least of 0.7 meters.

To seal the tab to the Spa, use a special elastic silicone for aquatic installations.

### ATTENTION

Leave a trapdoor spa access for maintenance. Never cover with concrete. LEAVE 70cm CLEARANCE AROUND THE SPA. ✘

Never fill the hot tub's upper profile with cement or any other material that expands/ contracts differently to the shell. This would lead to the hot tub cracking. Never concrete over the hot tub's pipes or accessories.



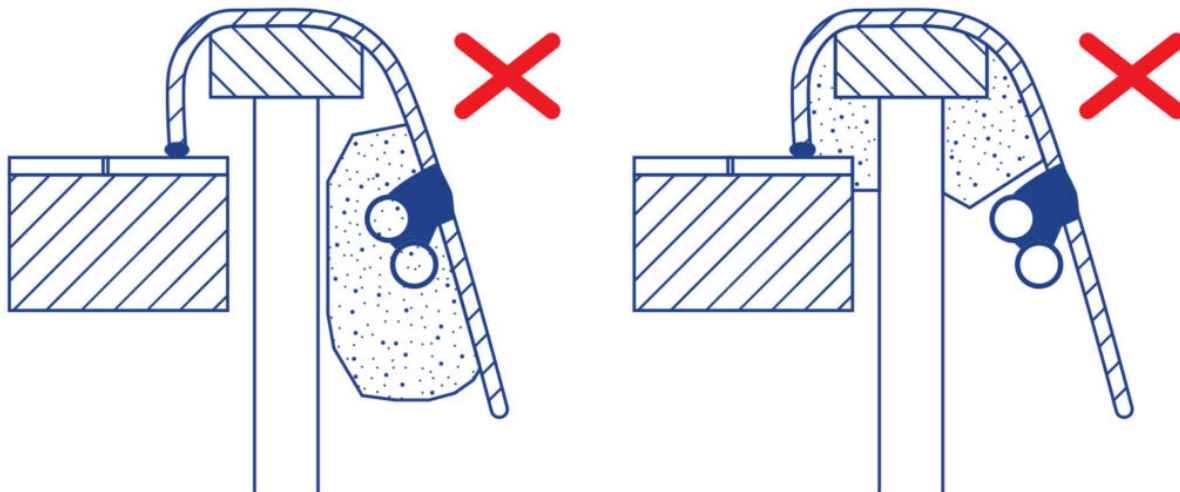

## ESSENTIAL SPA WARRANTY INSTRUCTIONS

To ensure the longevity of your spa furniture, it is important to follow these instructions focusing on the ventilation of the furniture:

1. Our spa furniture requires ventilation
2. Lack of ventilation can lead to warping of the spa panels.

1

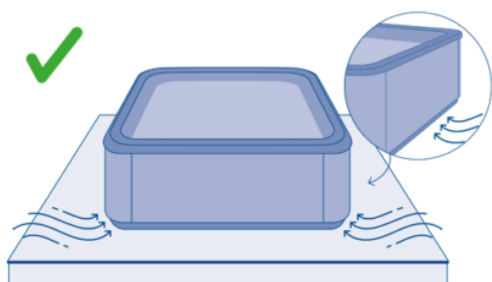

2

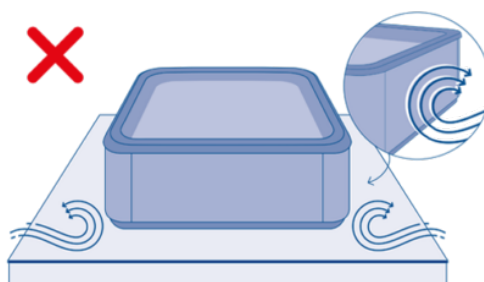

Be sure to provide adequate ventilation for your furniture to prevent possible warping.

### ATTENTION

The spa warranty does not cover any damage or deformation of the cabinet panels in the event that the spa suffers from a lack of ventilation due to the type of installation.

- A. A spa partially or completely covered by any type of decking type construction.
- B. A spa that is buried or semi-buried in the ground
- C. Material in contact with the base of the spa (stones, wood, artificial turf...) that is placed directly on the ground and in contact with the base of the spa, hindering the necessary ventilation.

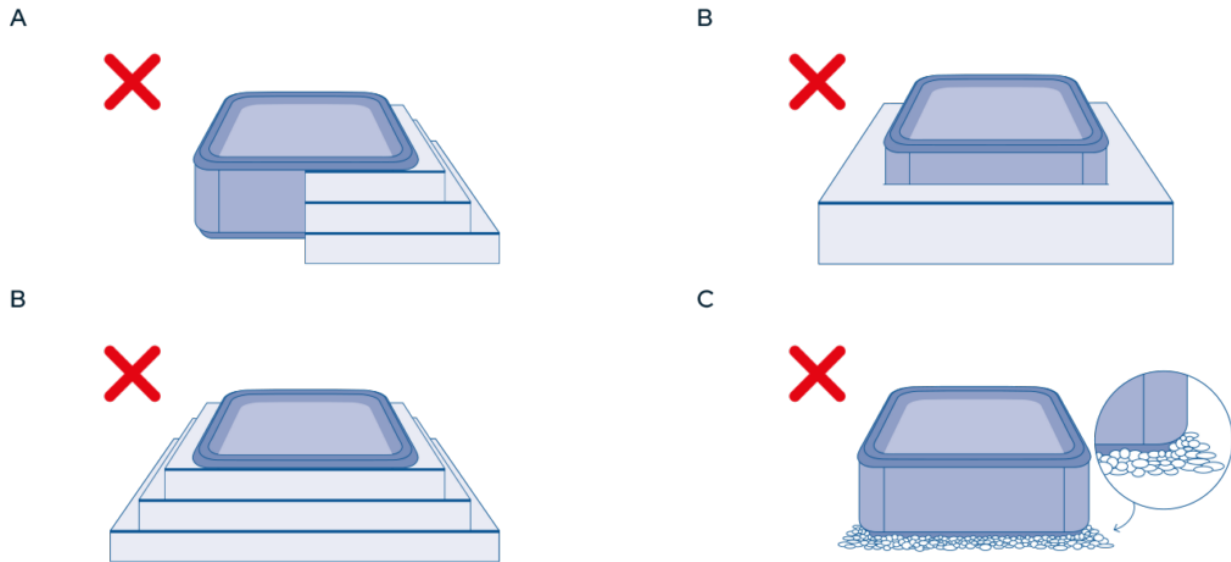

### 3.3. Description of the installation

When the hot tub is installed in a suitable location, the hot and cold water outlets need to be installed for automatic filling. A water seal (siphon) also needs to be installed in the drain area.

#### WATER SUPPLY

1. Carefully remove the hot tub's left panel (position yourself in front of the three flat cushions).

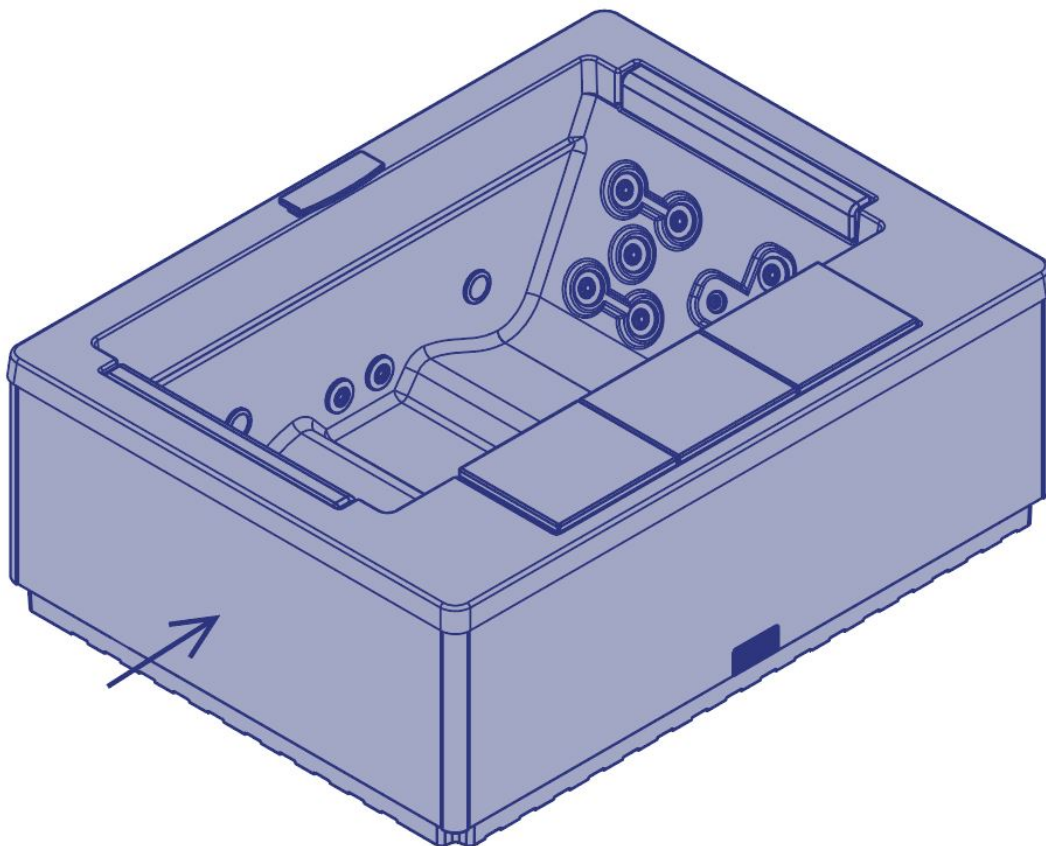

2. Connect the two water supply pipes with a G 3/8" male thread (see the image below). Connect the hot water outlet with the ball valve to the red valve, and the cold water outlet to the blue one.

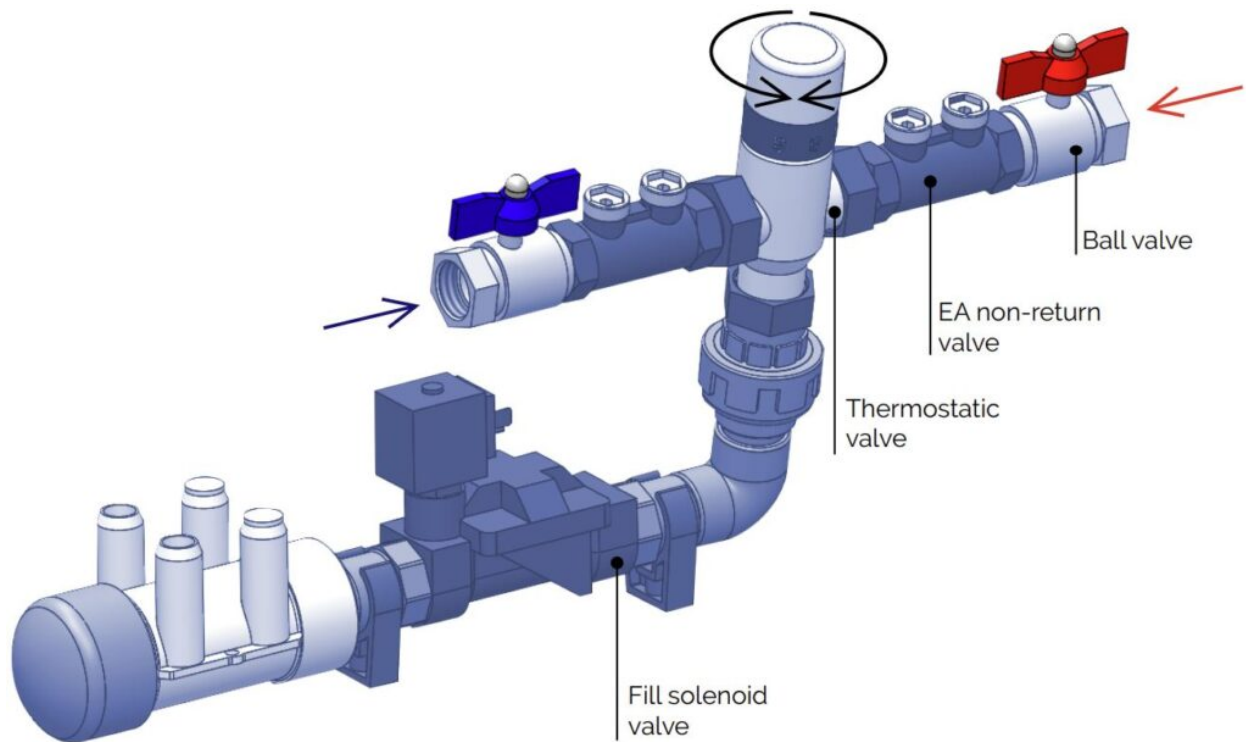

When this is done, the thermostatic valve receives cold water from the network water supply and hot water from the Domestic Hot Water (DHW) system where the hot tub is located. This makes it possible to set the desired temperature at which the hot tub is filled throughout the waterfall.

To adjust the water temperature, see section 4. Start-up.

### **WATER SEAL (SIPHON)**

It is necessary to install a water seal, just behind the thermostatic valve. This prevents bad smells from passing into the area where the hot tub is located. It must have the required characteristics and comply with the wastewater regulations in each country.

It must be installed at the outlet of the hot tub's drain loop (as shown in the image below) and connected to the building's sewage system, into which all the water will be drained.

Connection for  
the water seal

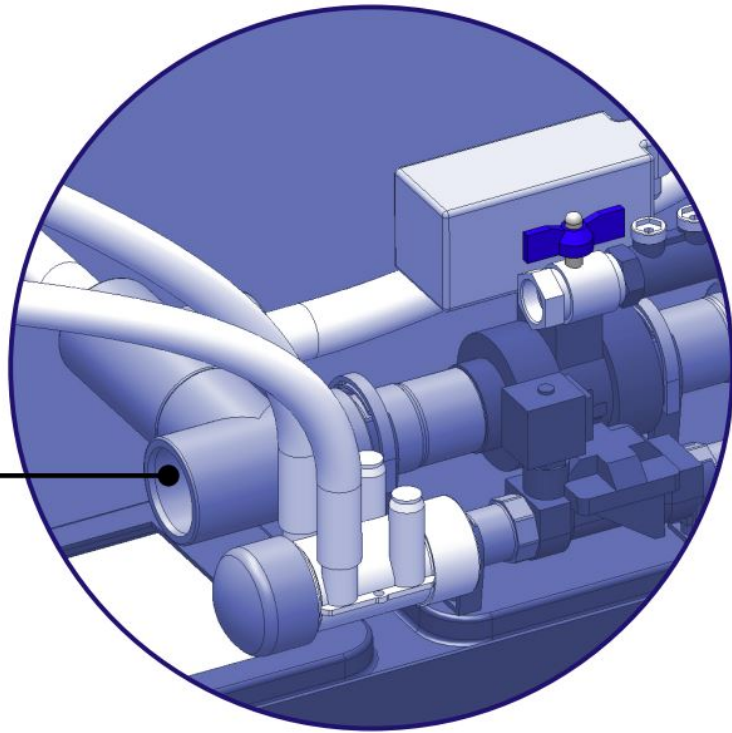

The water seal must be connected via a plain ended PVC pipe that is 50 mm in diameter.

### 3.4. Drainage

The drain loop consists of two drains that are internally connected in front of the drain solenoid valve (SV). After the SV, the overflow loop is connected to the drain loop and, from there, to the drainage system via the water seal.

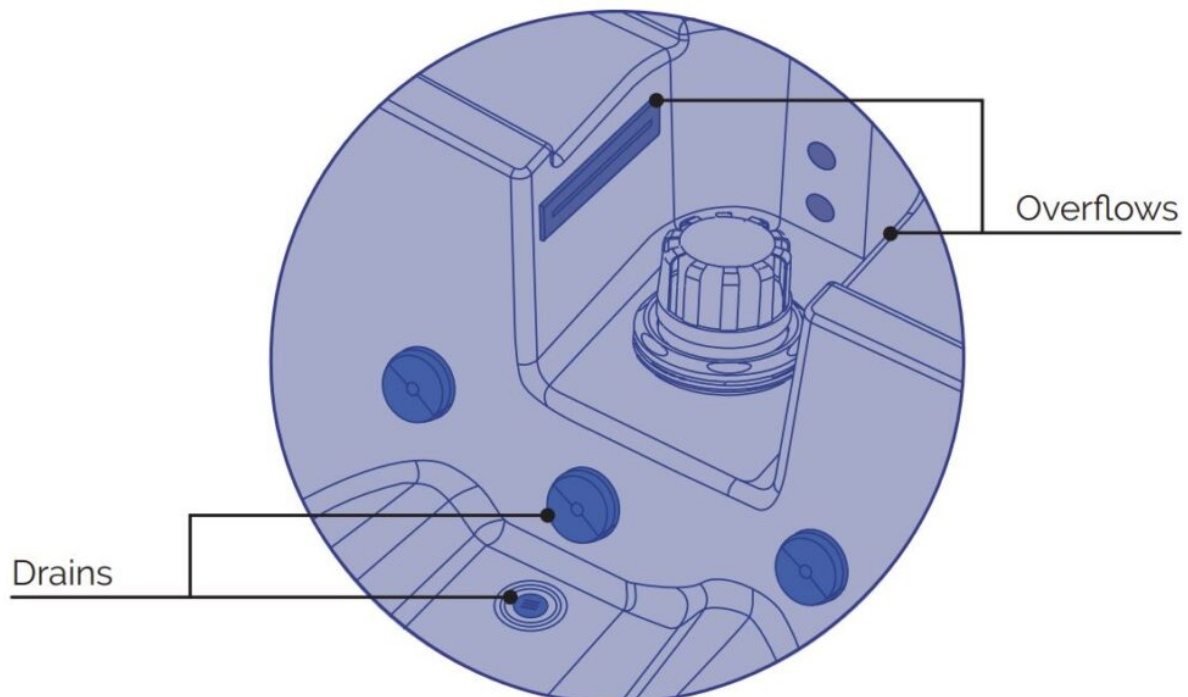

When following a continuous water filling process, the hot tub has an overflow loop composed of two overflows that are located above the height of the telescopic filter. They discharge the excess water into the building's drainage system after it passes through the water seal (not supplied with

the spa), regardless of whether the SV is open.

Due to empty the Spa, "Drain" button should be manually pressed.

The water then flows through the drains at the bottom of the hot tub, towards the drain solenoid valve, which remains open for 240 minutes. Then from the SV to the drainage system.

Drain function can be manually interrupted at any time by manually pressing the "DRAIN" button again.

When draining mode is activated, the massage pump is disabled.

### Draining by mechanical switch

Flashing blue light will be activated during draining cycle (draining mode switch picture).

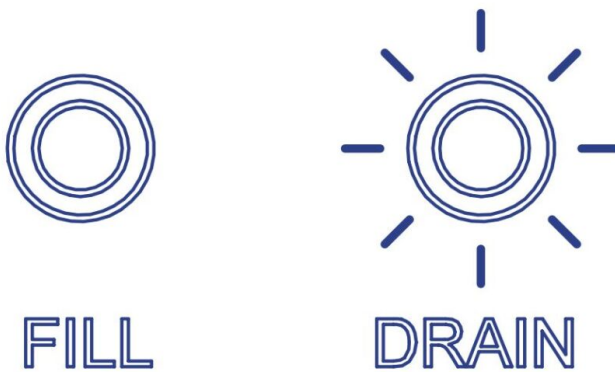

240 minutes later, drain electrovalve will close automatically (OFF mode) and flashing blue light will turn off.



### FAQS

- While filling process, draining switch can be activated manually and filling process is automatically stopped.
- While draining cycle, it is not possible to activate the fill switch manually. Draining switch must be pressed again to turn off and fill switch must be pressed to start new cycle.
- In the event of an electrical power failure during filling, the process stops and upon returning mains voltage, filling process turns on and it is stopped until the pre-established maximum water level is detected.
- In the event of an electrical power failure during draining cycle, draining electrovalve will remain open and will empty completely. When the mains voltage is restored, draining



electrovalve will automatically close for safety.

- In the event of an electrical power failure during electrovalve closing process, it will remain in that position; upon returning the mains voltage it will automatically close totally for safety.

Whenever the spa is drained, the filter should be cleaned (and drained/dried when proceeds).

### ATTENTION

Remember that when you drain your spa not all of the water runs off.

If your spa is not going to be used for long periods, especially in winter, remove any stagnant water on the seats and on the bottom of the spa with a sponge. Any water remaining in the pipes can be sucked out through the water and air nozzles using a liquid suction pump. The pumps must also be emptied through the drain plug. 

When preparing to drain the spa, proceed with the following recommended steps described below.

1. Start draining up to the halfway point of the spa.
2. Clean any dirty on the surface where stains are visible, such as in the water level mark.
3. Drain all the water until the spa is totally empty.
4. After that, the drain and the ground from the spa must be cleaned in order to ensure that no water is left in it.

Regular cleaning is recommended.

See section 6.5. Acrylic care to check the specifications that should be considered regarding the acrylic's cleaning.

### 3.5. Filling the spa

The fill solenoid valve, which is activated manually from the mechanical switch on the furniture panel, allows the water, which has already been mixed at the desired temperature, to flow into the spa. Filling takes place through the waterfall.

Spa is filling to L1 massage sensor, at that point control panel functions are activated automatically. Then continues up to L2 level sensor detection, when filling cycle is automatically closed once the water level is stabilized. If the manual button is not pressed again, blue flashing light becomes solid and the auto-fill function remains activated automatically in case the level drops again due to overflow or evaporation.

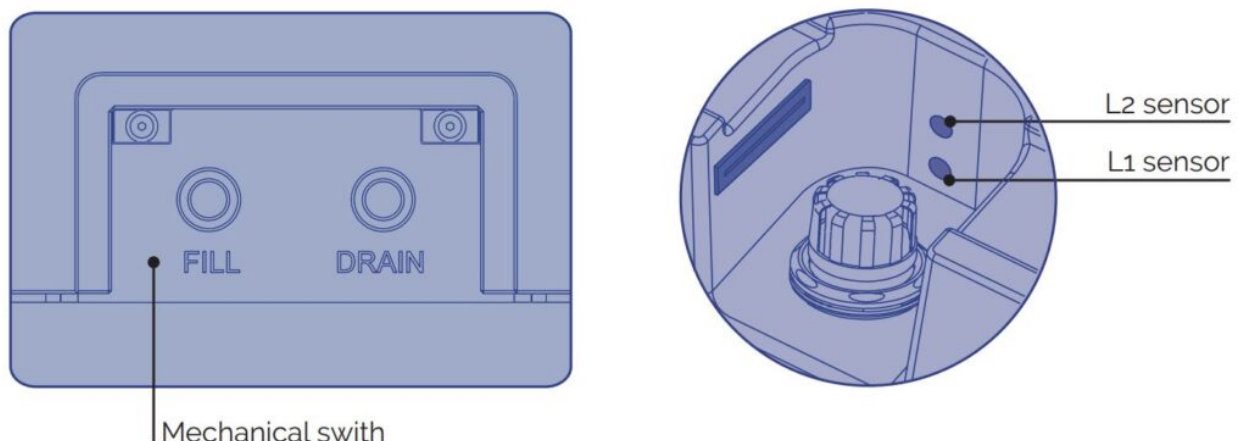

## Filling by mechanical switch

Flashing blue light is activated during filling cycle until the water level sensor is detected, then filling electro valve closes automatically. (filling mode switch picture).

NOTE: Filling waterfall should open and close two or three cycles during maximum water level stabilization process.

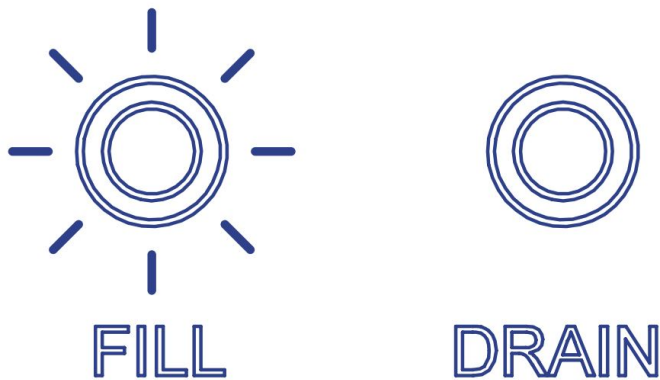

Flashing blue light stabilizes when spa is fully filled.



During filling stable blue light, filling cycle will be activated automatically in case of evaporation or overflow of the internal water until maximum water level again.

NOTE: If the switch is manually deactivated once filled, it will not fill automatically if the water level decrease.

Automatically, if L2 sensor does not detect water, it fills again.

See section 6.2. Water maintenance to see the specifications that should be considered regarding the water's characteristics.

The use of tap water for filling the spa is recommended to reduce the influence of unwanted substances such as minerals.

Adequate water supply is required for filling the spa in compliance with all local water use regulations, and the parameters should be adjusted before the spa is used for the first time.

## 3.6. Electrical connections

### ATTENTION

This equipment cannot be connected to a normal plug.

This equipment requires suitable electrical installation. This should be done by a specialised fitter following local electrical safety regulations of each country.

The electrical input of the Spa should always be protected by a highly sensitive differential. A 30mA differential is recommended.

Earthing connection is essential.

Use a suitable section cable bearing in mind the power of the Spa and distance to the control panel.

Always follow instructions given in the Safety Warnings chapter of this manual 

### **WARNING – RISK OF ELECTRIC SHOCK**

The electrical supply should be switched off (differential in the OFF position or disconnect the cable from the mains) before carrying out any work.

Never try to access an electrical component unless you are qualified or are the Head of Maintenance.

Always use suitable personal protection equipment and tools when handling electrical equipment.

Never access electrical elements if you are wet, particularly if you have wet feet.

Do not connect the electrical equipment (differential in the ON position), if the Spa is empty of water. 

### **SPA CONNECTION STEPS**

1. Locate the electrical control panel and open the side panel of the cabinet which gives access to the electrical components.

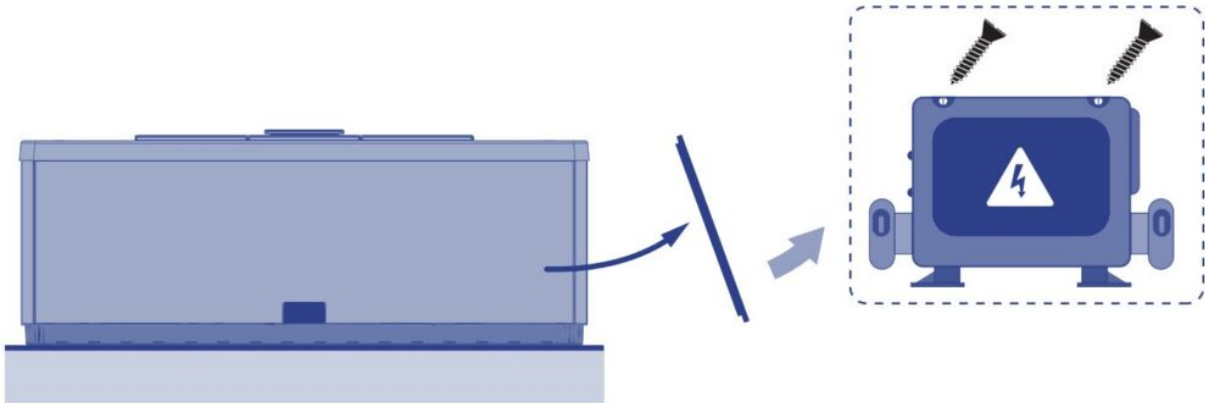

2. Open the control cabinet and connect the spa's electrical panel to the differential.



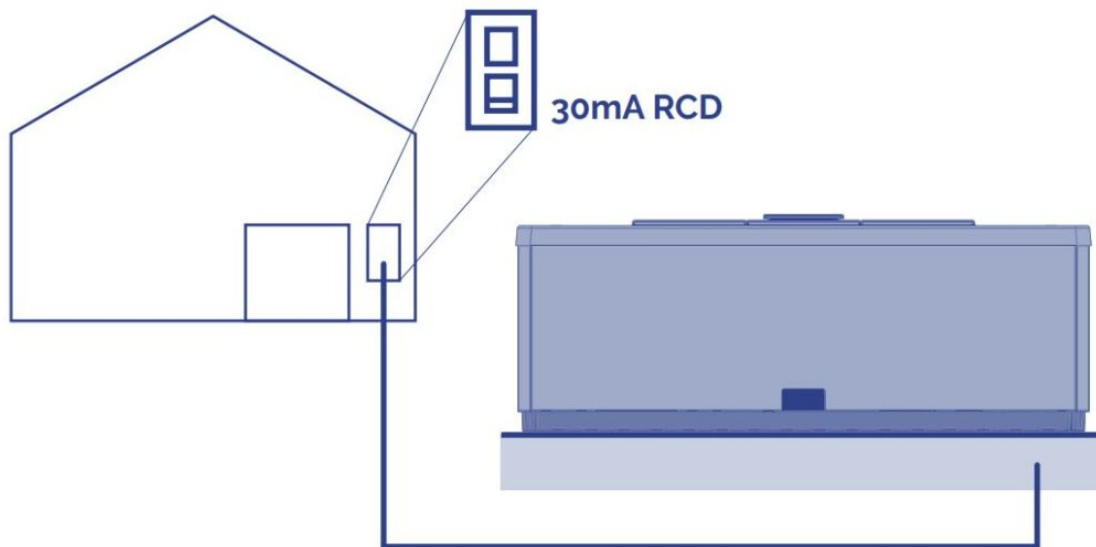

**WARNING**

Before making the electrical connections, you must check the water fittings for cold water, hot water, and the drain with its corresponding siphon.

**INSTALLATION OF THE DIFFERENTIAL**

The electrical installation should incorporate a high-sensitive 2-pole differential in the general mains input panel (the differential is not supplied with the Spa).

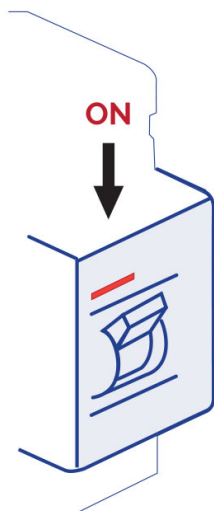

**WARNING**

It is essential that the owner of the Spa tests the differential switch at least once a month, to check its good working order. Check that the differential is in the OFF position. Do not place the differential in the ON position until the Spa is filled with water.

**CONNECT THE ELECTRICAL CONTROL PANEL TO THE DIFFERENTIAL SWITCH** Before carrying out any work on the Spa, make sure it is disconnected from the mains (differential switch in the OFF position, or disconnect the cable from the mains).

Use a suitable cable from the differential switch to the electric cabinet of the Spa, depending on the location and applicable law. The cable section will vary depending on the Spa model and the distance of the installation.

The required kW is indicated in the appendix Technical Specifications of the Spa. The maximum power must be considered, depending on the “High Amp” or “Low Amp” configuration.

## **DIP Switch Functions**

### Fixed-Function DIP Switches

A1 Test Mode (normally off).

A2 In “ON” position, add one high-speed pump (or blower) with Heater.

A3 In “ON” position, add two high-speed pumps (or 1 HS Pump and Blower) with Heater.

A4 In “ON” position, add four high-speed pumps (or 3 HS Pumps and Blower) with Heater.

A5 In “ON” position, enables Special Amperage Rule B. See Special Features Section under Configuration Options for functionality with your system. In “OFF” position enables Special Amperage Rule A.

A6 Persistent memory reset (Used when the spa is powering up to restore factory settings as determined by software configuration). A2, A3 and A4 work in combination to determine the number of high-speed devices and blowers that can run before the heat is disabled. e.g.,

A2 and A3 in the ON position and A4 in the OFF position will allow the heater to operate with up to 3 high-speed pumps (or two HS Pumps and Blower) running at the same time. Heat is disabled when the fourth highspeed pump or blower is turned on.

NOTE: A2/A3/A4 all off = No heat with any high-speed pump or blower.

### **Assignable DIP Switches**

A7 In “ON” position, enables a 5-minutes cool down for some gas heaters (Cooling Time B). In “OFF” position, enables a 1-minute cool down for electric heaters (Cooling Time A).

Undesignated switches are not assigned a function. The Electric Specification Sheet attached at the end of this manual indicates both the “Low Amp” and the “High Amp” power.

## **Special Features**

Feature	Default
Special Amperage Rule A	No limitation
Special Amperage Rule B	2 high-speed pumps max. Blower turns off with 2 high speed pumps – in Setups 1-4, 6-10, 13, 15, 16, 18 No limitations – in Setups 5, 11, 12, 14, 17

## CABLE SECTION

To determine the cable section of the electrical installation, see the values indicated in this sheet and the following table.

	KW required											
	2,1	2,5	2,8	3,2	3,5	4,4	5,3	6,2	7,0	7,9	8,8	
Distance	Nominal section of the cable in mm <sup>2</sup>											
6 – 11 m	2,5	2,5	2,5	2,5	4	4	6	10	10	10	10	
11 – 15 m	2,5	2,5	4	4	4	6	6	10	10	10	10	
15 – 20 m	4	4	4	6	6	6	10	10	10	16	16	

For longer distances, increase the cable section accordingly.

Some configurations may require installing 1 32A line, 2 16A lines or even one three phase line (3 x 16A) to cover the power required by the Spa.

The different configuration options of the electrical control panel are explained further on in this Installation Manual.

Remember that the installation and any changes in the electric configuration must be carried out by qualified personnel, following the current regulations in each country. The manufacturer shall not be responsible for any damage caused by an improper installation, or an installation performed by non-qualified personnel.

### WARNING

Pay attention to the position of the maximum consumption switch. The Spa will not operate properly if a cable not corresponding to the distance and power of the Spa is used, and the electrical circuits may overheat which may cause an electrical accident. Always use cable with the suitable section of maximum consumption. **In the event of doubt between two values, always use the cable with the greater section.** 

To connect the supply to the electrical panel of the Spa, locate the packing gland positioned at one end of the electrical panel.

Make sure that there is no electric current in the connection cable (differential switch in the OFF position).

Take the cable to the Spa electrical panel.

Open the cover of the electrical cabinet, insert the feed cable through the free side.

Attention: the indicated blue cable is neutral, and the brown cable indicates the line or phase.

Fasten the terminals as indicated in the following diagrams and the type of electrical supply.

### SINGLE LINE

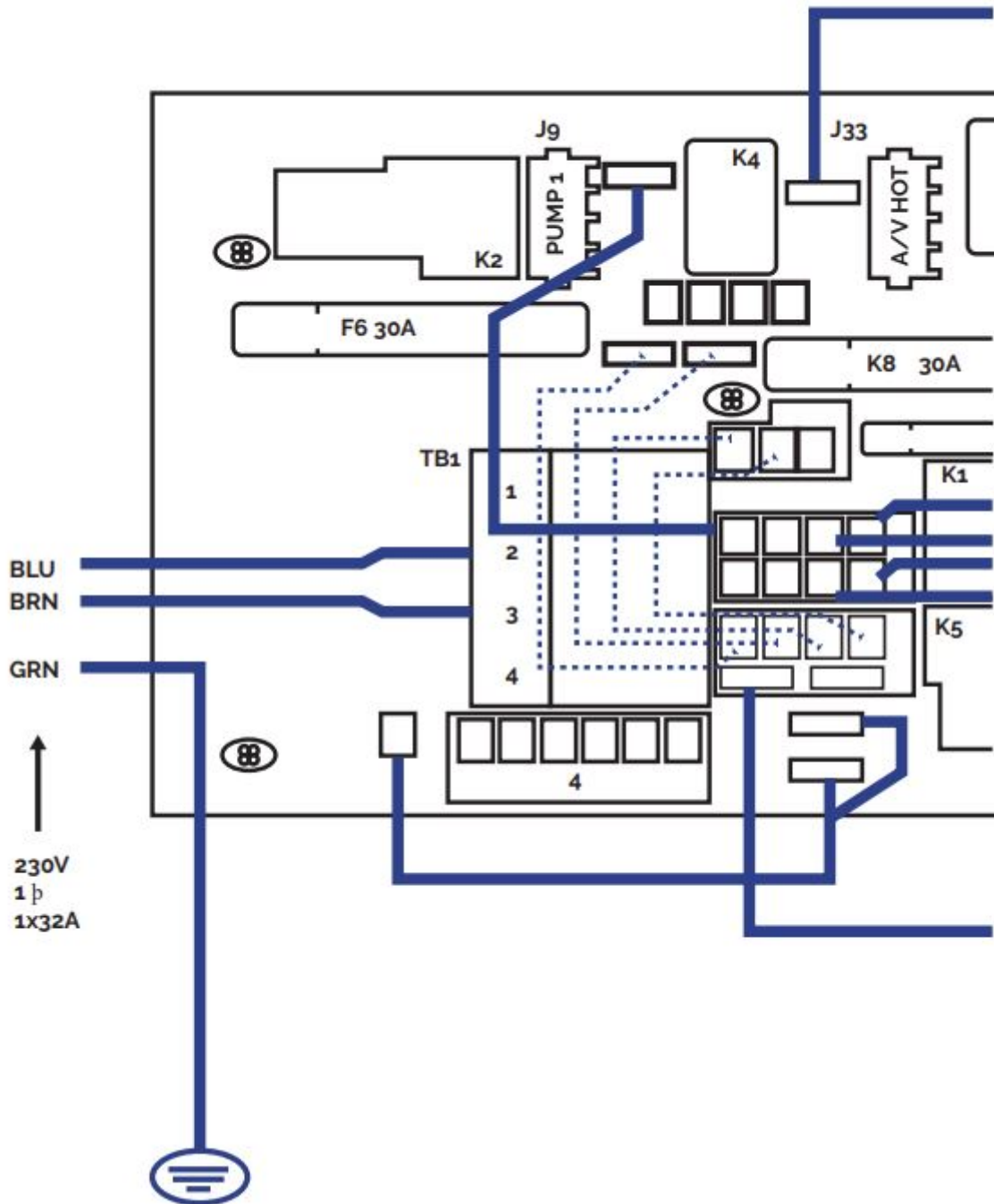

### THREE PHASES 400V

Three-phase line 400V BP21G1WL

Remove bridges:  
J51- J88 and J52-J62 ○

Changes these bridges:  
J60-J36 -> TO J60-J45 ○

J41-J12 -> TO J41-J79 ○

Power requirements:

3 Services 5 wires: Line 2, Line2, Line 3, Neutral, Ground 400VCA, 50/60Hz 3 phase, 16A (Circuit breaker rating = 20A max each phase line).

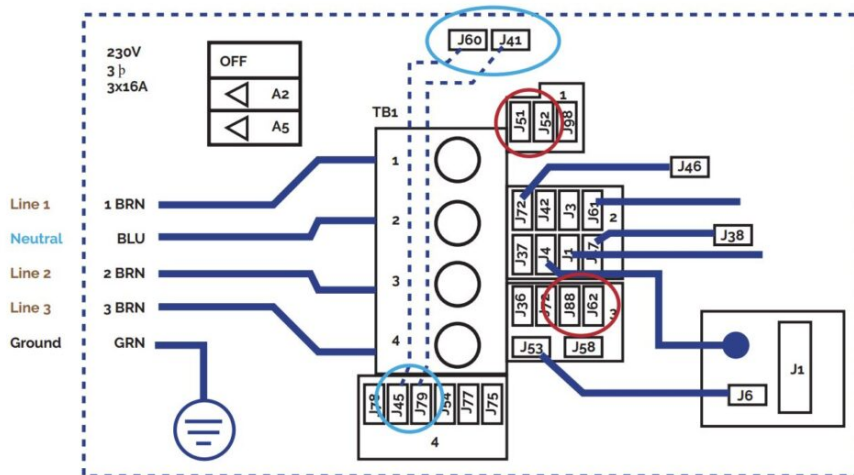

### Three-phase line 400V BP6013G1 & BP6013G2

Remove bridges:

disconnecting J51 and J58 ○  
disconnecting J52 and J36 ○

Changes these bridges:

J41 -J53 -> TO J41 - J54 ○

J60-J12 -> TO J60-J45 ○

Put DIP switches A5 on OFF and A2, A3 on ON position

Power requirements:

3- Service 5 wires: Line 2, Line 2, Line 3, Neutral, Ground 400VCA, 50/60 Hz\* 3 phase, 16A (Circuit breaker rating = 20A max each phase line). \*BP systems automatically detect 50Hz vs 60Hz

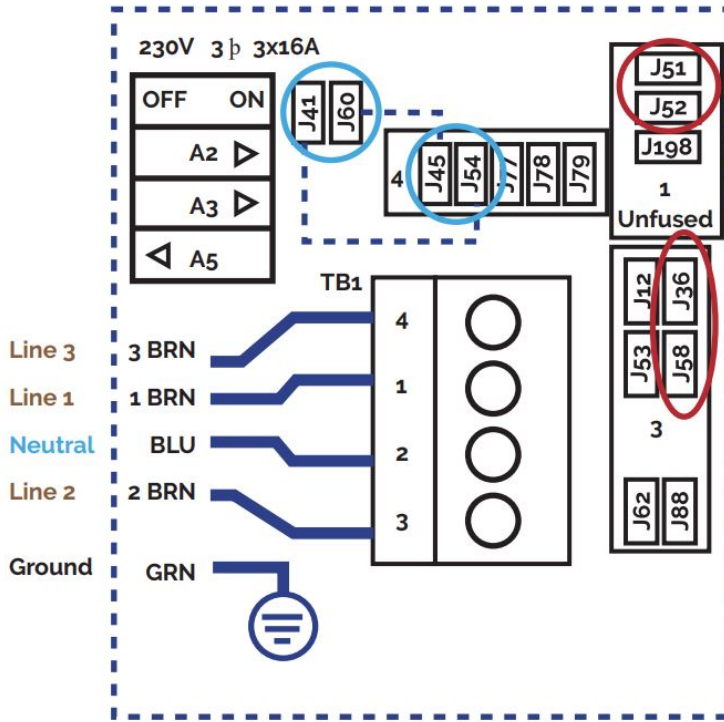

## WARNING

Correct earthing is essential.

The earthing circuit of the building should always be in perfect condition to guarantee the safety of Spa users. If you have any doubts on this, ensure that the earthing circuit is checked by a duly qualified person. The manufacturer will not be held responsible for possible damage caused by incorrect maintenance of the earthing circuit.

Fasten the earth cable (yellow and green) to the terminal on the outside of the control cabinet as shown in the following diagram.

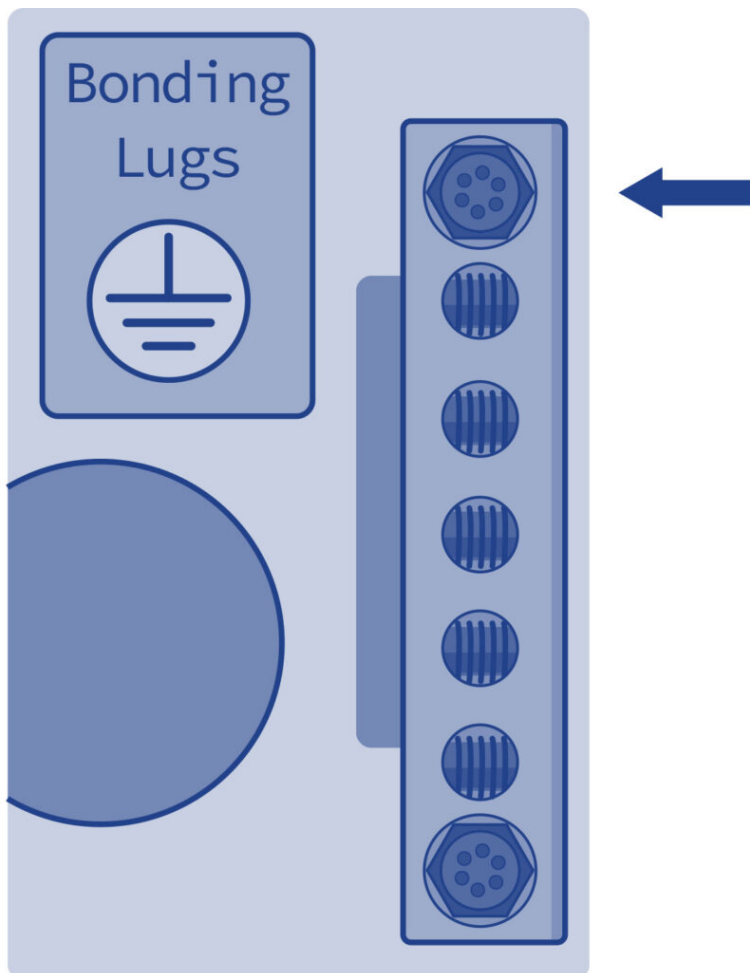

**WARNING**

Do not connect the electricity (differential in the ON position) until the Spa is filled with water. ×

## 4. Start-up

With the main residual-current device in the OFF position, clean the hot tub's shell to prevent any particles from the installation work being absorbed into the components/ loops or clogging them.

Then, switch the residual-current device into the ON position, the stopcocks are opened, and the filling is manually activated from the control panel by pressing the "FILL" button. This opens the filling solenoid valve.

Adjust the thermostatic valve to set the desired inlet water temperature. There follows an illustrative table for proper operation.

Knob position (bar)	0,5	1	2	3
Temperature (°C)	20	28	37	42

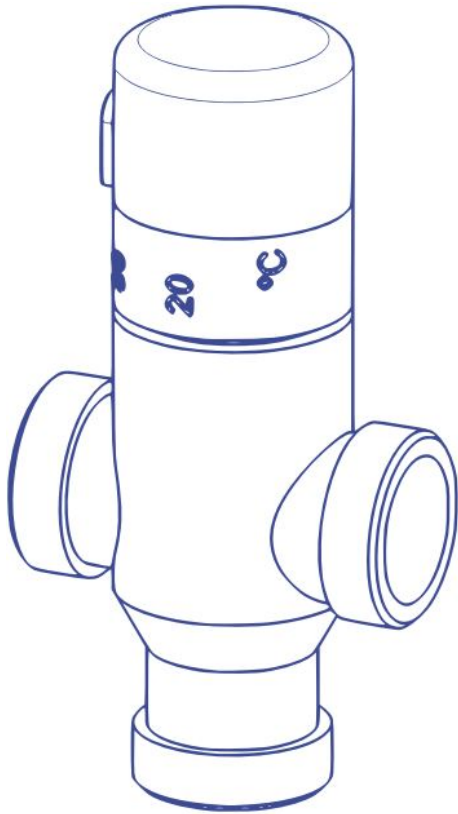

If the cold water inlet temperature is not the same, or you want a temperature in the hot tub that is different to those in the table, you may have to change the position slightly as appropriate.

We recommend checking the outlet temperature regularly to ensure that it is optimal and adjusting it when necessary.

When the operating water level has been reached, check for leaks of any kind and, if there are none, turn on the filtration pump to expel the air inside the loop and fill it with water. To do this, see section 5.6. Filtration by setting the activation time to 0 so that it comes on immediately. Then, follow the instructions in that section to set the desired filtration intervals.

We recommend inspecting all connections to check for any leaks after turning on the loops and rechecking after 30 minutes of operation.

After performing these checks, complete the Warranty form that comes with the product and return it to the manufacturer.

## **5. Operating instructions**

### **5.1. Warnings on the use of the spa**

Carefully read the following lines regarding accident prevention.

- Do not start-up the Spa unless it is full of water.
- This appliance can be used by children aged from 8 years and above and persons with reduced physical, sensory, or mental capabilities or lack of experience and knowledge if they have been given supervision or instruction concerning use of the appliance in a safe way and understand the hazards involved.



- Children shall not play with the appliance.
- Cleaning and user maintenance shall not be made by children without supervision.
- Take extreme precautions to stop children from entering the Spa unattended. To avoid accidents, ensure that children are supervised at all times. Never leave children alone in the Spa. Take care when entering and leaving the Spa to avoid slipping on wet surfaces.
- Do not allow anybody to play with sharp or metal objects inside the Spa, which could damage the acrylic surface.
- Do not allow any user to access to the electrical parts of the Spa.
- Do not use electronic devices inside the Spa.
- Do not let animals go inside the Spa.
- Do not fill the Spa with other liquid other than fresh, duly treated water.
- Do not fill the Spa with hot water (maximum 35°C); let the water heat by itself, otherwise it could damage the temperature probes (see “Temperature Adjustment”).
- Do not use the Spa immediately after intense physical exercise.
- Do not use the Spa if you are suffering from a contagious disease or 14 days after recovering from a contagious disease. 25 ENG
- In order to guarantee maximum safety when bathing all our Spas use pumps designed to suction water from anti-vortex, safety drain covers, located on the floor of the Spa. Take special care that these drain covers are not covered by any object or the users (pieces of clothing, hair, legs, etc.). For safety reasons, your head should always be outside the Spa in order to avoid drowning. Do not use the Spa if the drain covers are broken, damaged or unassembled, as apart from damaging the Spa, it could also lead to a risk of drowning.
- The headrests of your Spa are made of synthetic foam, which can be damaged in high concentrations or bromine or chlorine, or low levels of ph. Make sure that when adding chemical products, the headrests are neither totally nor partially immersed in the water. If necessary, remove them until the chemical products have taken effect. Damages resulting from improper use shall not be considered under the guarantee of the product.
- The Spa includes a cover designed to protect the acrylic surface from sunrays when it is not being used. This cover will also help to keep the water warm and for sun protection that could damage the acrylic material of the Spa. The cover will be required.
- The appliance should be installed through a residual current device (RCD) with a rated tripping current not exceeding 30mA.
- The cover is designed to protect the spa, not to bear weight. Not even water or snow. Do not place objects on top of the cover. Do not allow people or animals get on the cover. Periodically remove snow to prevent build-up.
- The water should be disinfected thoroughly before using the Spa, especially if it has not been used for a certain period, whether it has been left with or without water inside. During periods of non-use, traces of stagnant water may remain, which may cause the growth of microorganisms potentially dangerous for health. Therefore, disinfect the Spa as indicated in this manual, ensuring that the pH and disinfectant parameters are suitable.
- For spas that rely on a specific outlet, it should not be removed while the spa is being used.
- The user should check the water temperature before getting inside the spa.
- The use of alcohol, drugs or medication before or during the spa use may cause unconsciousness with the possibility of drowning.

### **WARNING - RISK OF ACCIDENTAL DOWNING**

Extreme caution should be exercised to prevent unauthorized access to the spa by children, especially those under 5 years of age. This can be achieved by adult supervision to monitor access or by installing a protective device in the spa. To avoid accidents while using the spa, ensure that children are under constant adult supervision. 

### **RISKS OF HYPERTHERMIA**

Prolonged, direct contact with hot water could cause hyperthermia. This occurs when the internal body temperature reaches levels above the normal temperature of 36.5°C. It is advised not to bathe for longer than 15 minutes.

Symptoms of hyperthermia are a sudden drop in blood pressure resulting in a sensation of dizziness with the possibility of fainting. 26 Water temperatures between 37°C and 40°C are only considered safe for adults without any health problems. Lower temperatures are recommended for most people and children. The Spa water should never be above 40°C.

Please note that the comfortable temperature range during use may be lower than the maximum safety temperature.

Persons with a medical condition or taking medication should consult a doctor before using the spa because some medications may cause drowsiness and/or affect heart rate, blood pressure and circulation.

### **ATTENTION**

Alcohol, drugs, or medicines could increase the risk of hyperthermia. It is not advisable for pregnant women, patients with high blood pressure, a heart condition, diabetes or under medication to use the spa. You should seek doctor's advice. 

### **ATTENTION**

To reduce the risk of injury/illness, the spa water should never have a temperature above 40°C. Lower temperatures are recommended for young children and when using the spa for more than 10 minutes. It is recommended that a doctor be consulted prior to use.

To reduce the risk of injury/illness, as excessively high temperature carries a high probability of fetal damage during early pregnancy, so that, pregnant women should limit the temperature and duration of use, and also consult a doctor advice. 

## **5.2. Systems**

Your spa is equipped with an electronic control system that will enable you to regulate the temperature of the water, choose the filter cycle that best suits your needs and activate the massage pumps and the blower pump. It will also enable you to turn on your spa lighting, change its colour and sequence.

The functions and how to execute the filling and draining options are described below.

### **TOUCH PANEL**



## MECHANICAL SWITCH ON THE FURNITURE PANEL

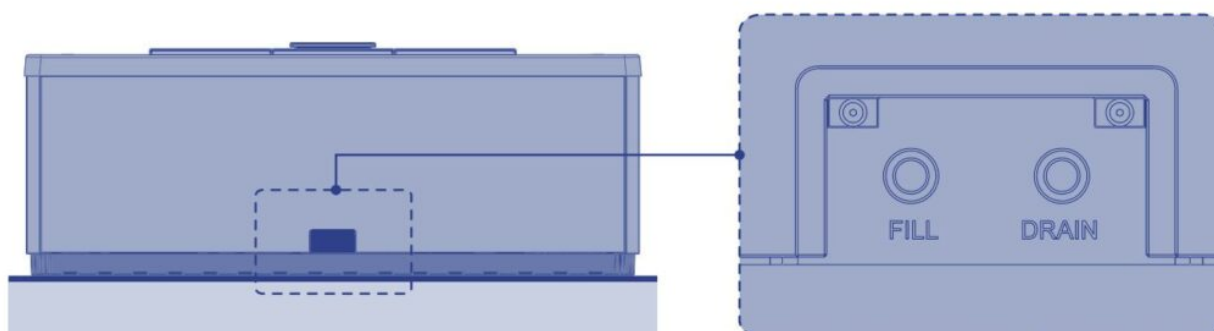

### 5.2.1. System start-up for Touch Panel

Important information about spa operations can be seen on the Main Screen. Most features, including Set Temperature adjustment, can be accessed from this screen.

The actual water temperature can be seen, and the Set Temperature can be adjusted. Time-of-Day and Filter status are available, along with other messages and alerts. The selected Temperature Range is indicated in the upper left corner.

A lock icon is visible if the Panel and/or Settings are locked. Near the bottom of the screen, at certain times an indicator may appear showing that a message is waiting. Touch this indicator to go to the Message Display Screen. On that Screen some of the messages can be dismissed.

When the spa is powered On, four dashes appear (A) in the Water Temperature display for one minute. The dashes indicate that the spa is checking the water temperature. After the pump runs for 1 minute, the dashes disappear, and the water temperature is displayed (B). The dashes may reappear after the pump has not run for one hour.

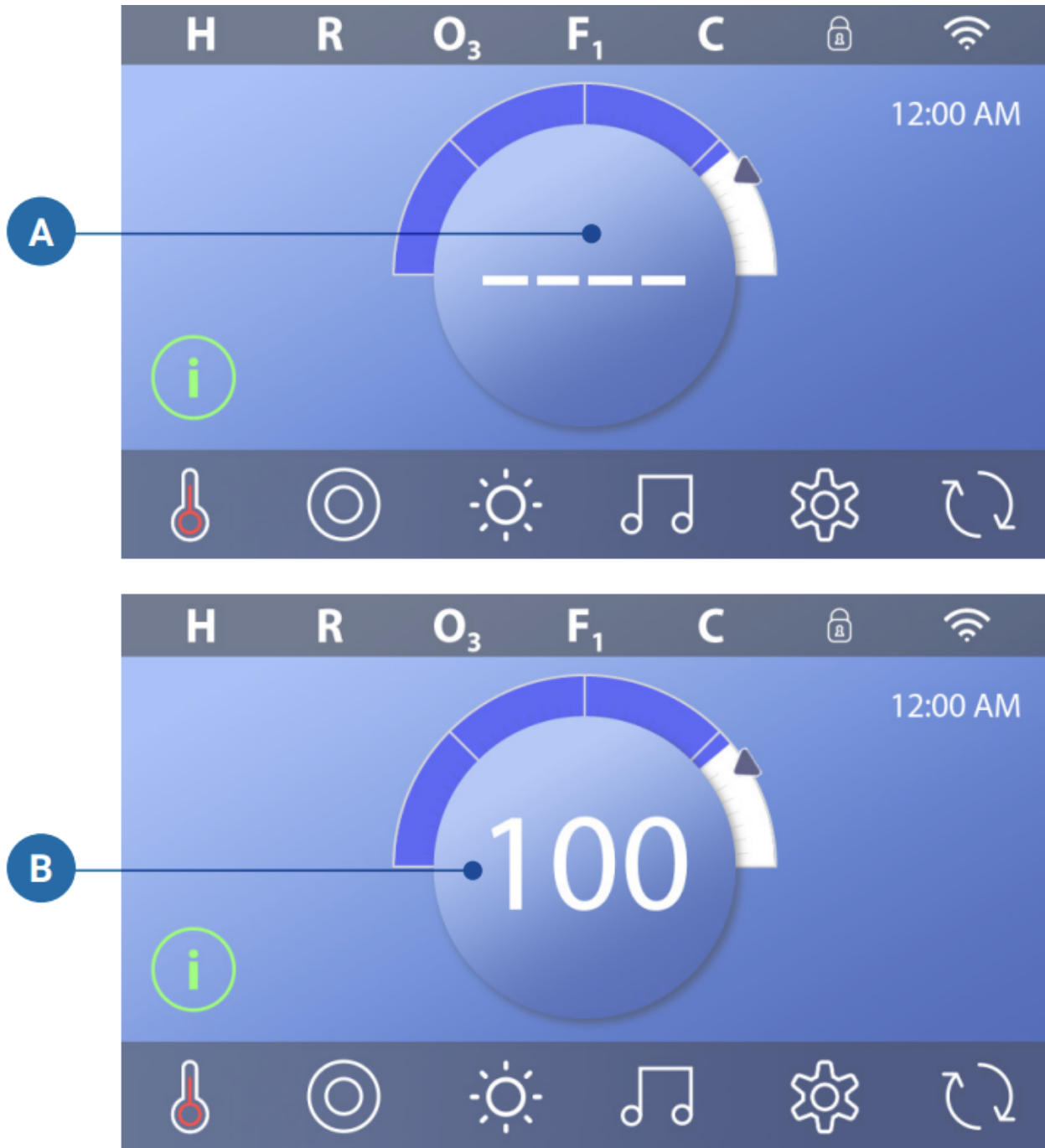

### 5.2.2. Control system for Touch Panel

MAIN SCREEN | TOUCH PANEL

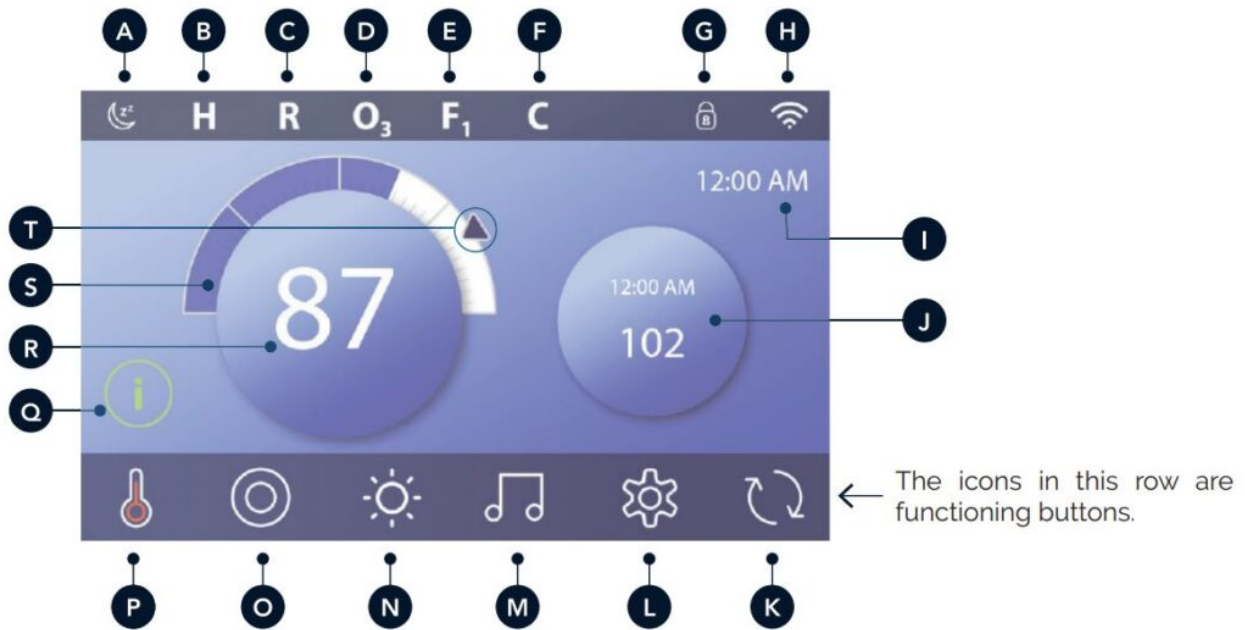

A - Panel Sleep

B - Temperature Range

High: H

Low: L

C - Heat Mode

Ready: R

Rest: R

Ready-in-Rest: RR

D - Ozone Runing: O<sub>3</sub>

E - Filter Cycles

Filter Cycle 1 : F<sub>1</sub>

Filter Cycle 2 : F<sub>2</sub> (OPTIONAL FEATURE)

Filter Cycle 1 & 2 : F+

F - Cleanup cycle (OPTIONAL FEATURE)

G - Panel Locked and/or Settings Locked

H - WiFi (Local or Cloud connection)

I - Time-of-Day

J - Secondary Button/Display

K - Invert Display

L - Settings

M - bba™ versions 2 and 3 (Balboa Bluetooth Audio)

N - Light (or CHROMAZONE™  if installed). Both icons change from white to color when these devices are powered On.

O - Spa

P - Heater Status

Q - Message Button (May Appear)

Information: 

Reminder: 

Error - Normal Error or Warning: 

Error - Spa will not function until fixed: 

R - Water Temperature

S - Water Temperature Bar

T - Set Temperature Arrow

## WAKE UP THE PANEL, NAVIGATION & COMMON BUTTONS | TOUCH PANEL

Controlling your spa is easy with the intuitive graphical user interface (GUI). This section describes how to navigate and use the GUI.

### Wake Up the Panel

The screen is blank when it is in sleep mode. When you touch the blank screen, one of three screens will appear:

1- The Main screen will appear (A3). The panel is awake.

2- The ① icon will appear (A2). Wake up the panel by pressing the ② icon and then the icon.

3- The hand icon will appear. Wake up the panel by pressing the hand icon (A1) and then swiping in the direction of the arrows.

The panel automatically goes into sleep mode when it is not used for a specified duration. The duration can be adjusted.



### Buttons

A variety of button styles provide quick access to functions and settings. The large temperature display is a button (B) that controls the Set Temperature. The whole bottom row of the Main screen contains buttons (C).



### Mini Player Button (Set Temperature/Time)

The Mini Player button gives fast access to the Set Temperature and time (D). Show or hide the Mini Player button by pressing the Heater Status button once (E).



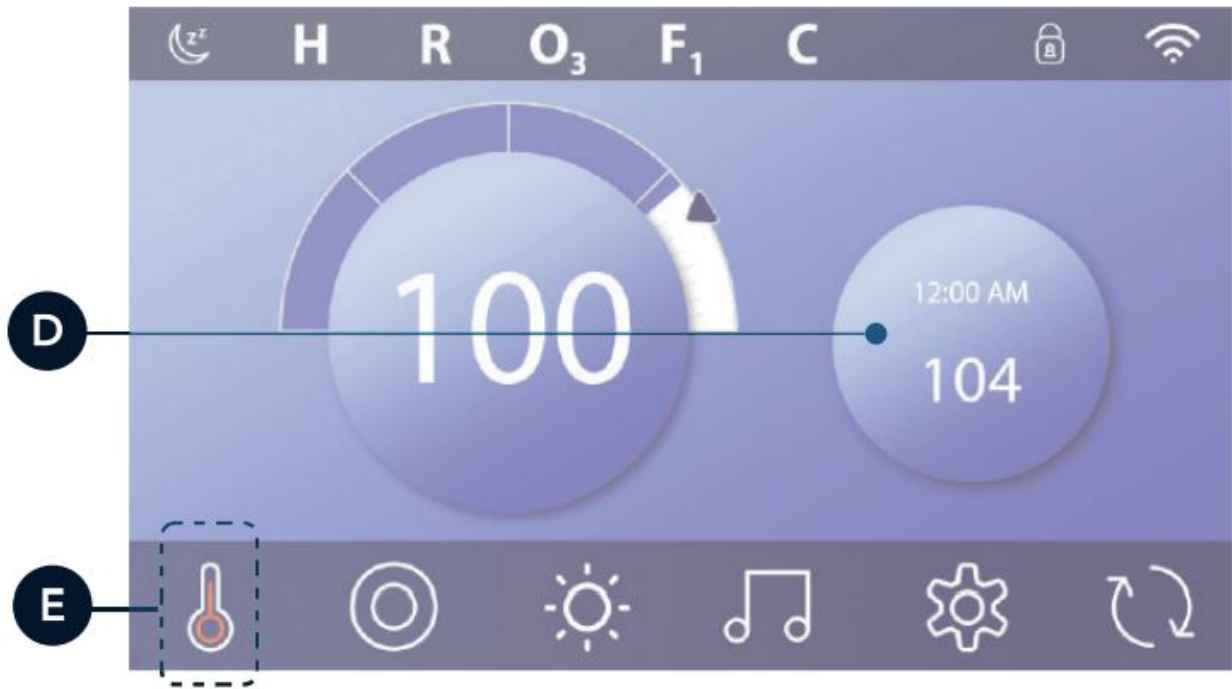

**Mini Player Button (Music)**

The Mini Player displays music controls (F) if your spa is equipped with bbaTM (Balboa Bluetooth Audio) and it is activated. Hide the Mini Player button by pressing the Heater Status button twice (G). The first press displays the Set Temperature/Time Mini Player button. The second press hides the Mini Player button.

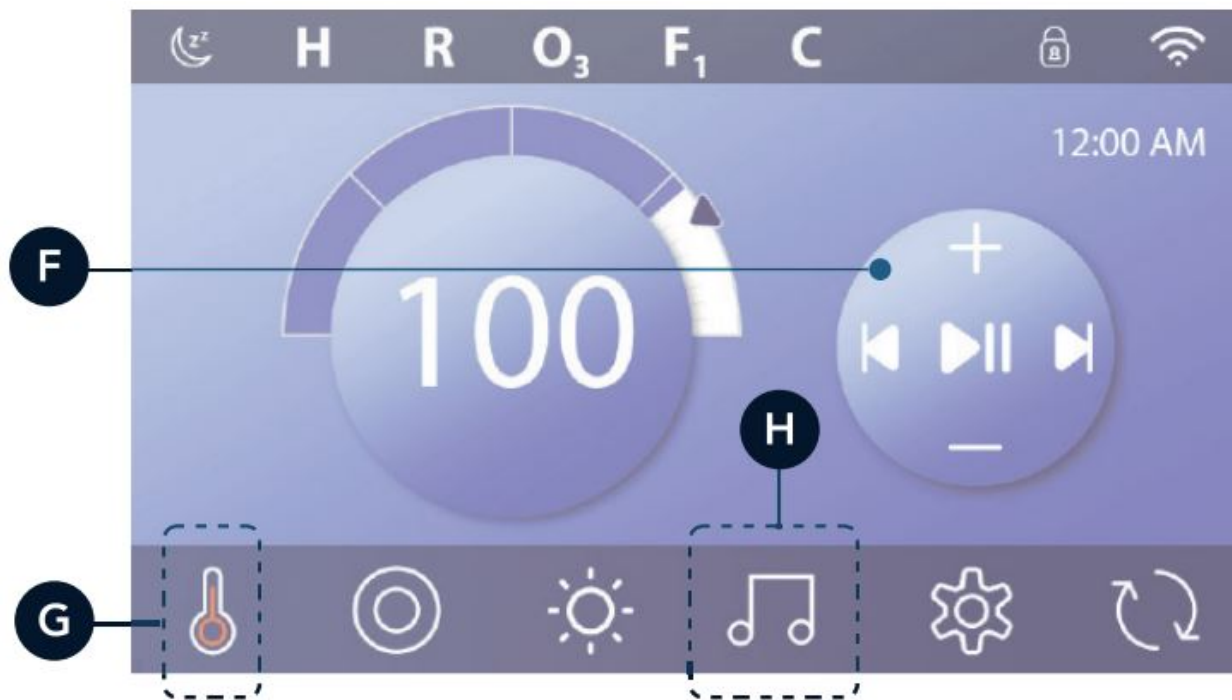

**bbaTM button (H)**

If bbaTM is activated, pressing the bbaTM button (H) once displays the Mini Player (F) with music controls. Pressing the bbaTM button (H) a second time opens the Music screen ( I ), If bbaTM is activated, a white ring appears around the button, as shown here ( I ).

If bbaTM is not activated, pressing the bbaTM button (H) once opens the Music screen ( I ).

If your spa is equipped with bbaTM, refer to the bbaTM user guide that came with the spa. If a

user guide was not included, please contact the spa dealer or spa manufacturer.



### Screen Names

Screen names appear in the top row of the screen. For example, this is the Settings screen (J). Screen names are referenced throughout this user guide.

### Navigation

Navigate screens and/or lists with the following buttons:



### Swiping & Selecting Items in Lists

Swipe a list (N) to find the setting you want. The list will have an arrow (M) that indicates the current setting. If your desired setting appears but is not aligned with the arrow, tap the desired setting to make it align with the arrow. The temperature list will disappear when you tap anywhere outside of it.



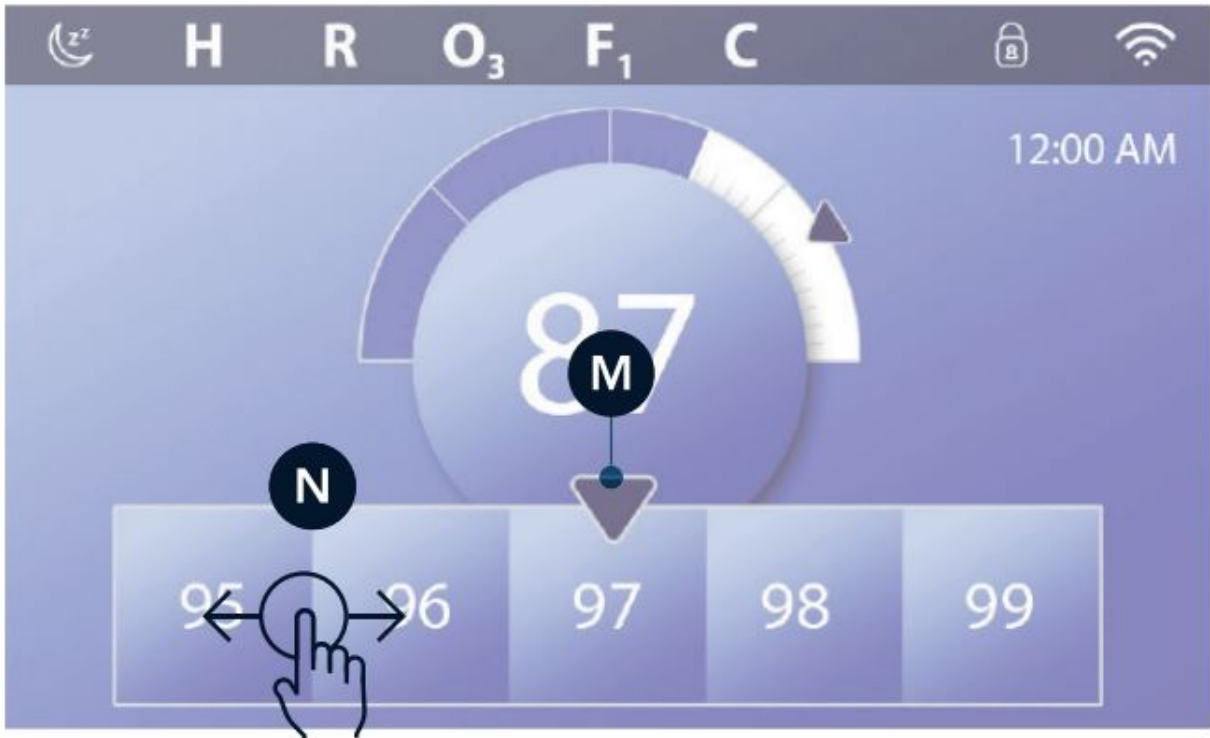

**Saving & Cancelling**

After you input a new setting, press the Save button (B). After you press Save, the change is complete. If you don't want to apply a new setting, press the Cancel button (A).

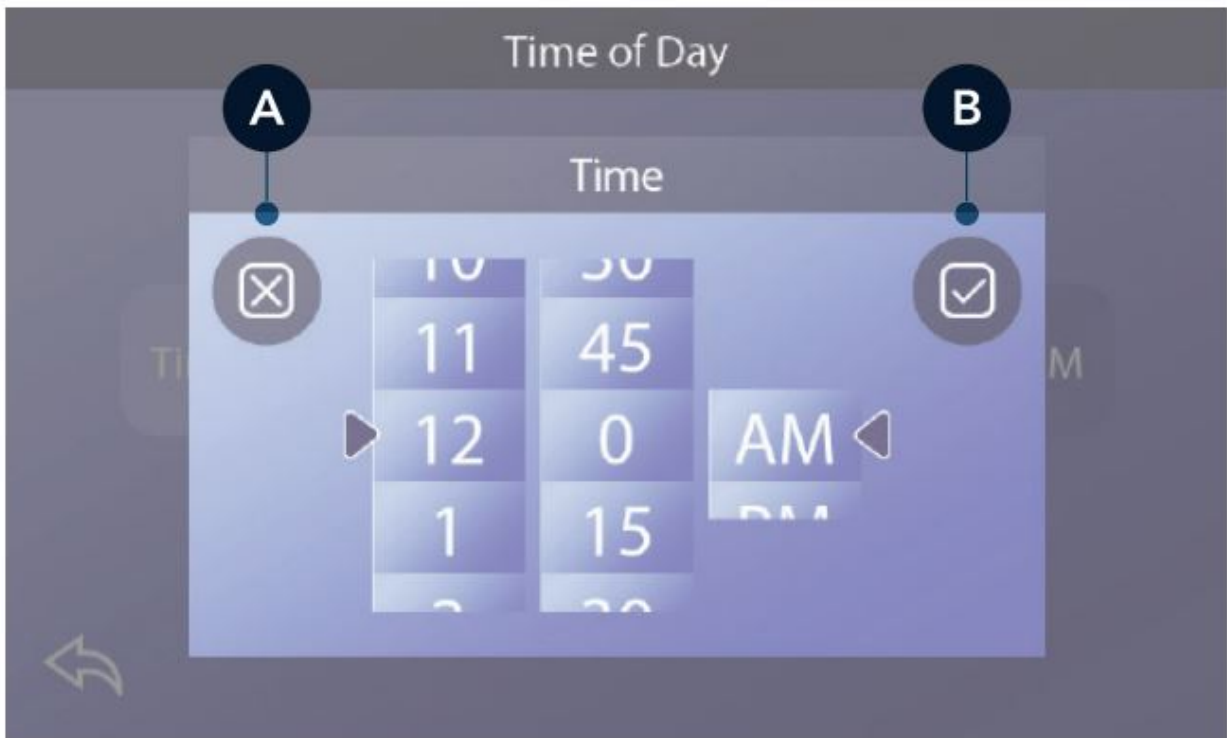

## Message Buttons

Message buttons provide reminders to help you keep your spa running smoothly. Message buttons also provide warning information that helps spa technicians with troubleshooting. When a message button appears (C), press it to view the corresponding message (D) or (G). Press the Exit button (E) to go back to the Main screen or press the Clear button (F) to dismiss the message.

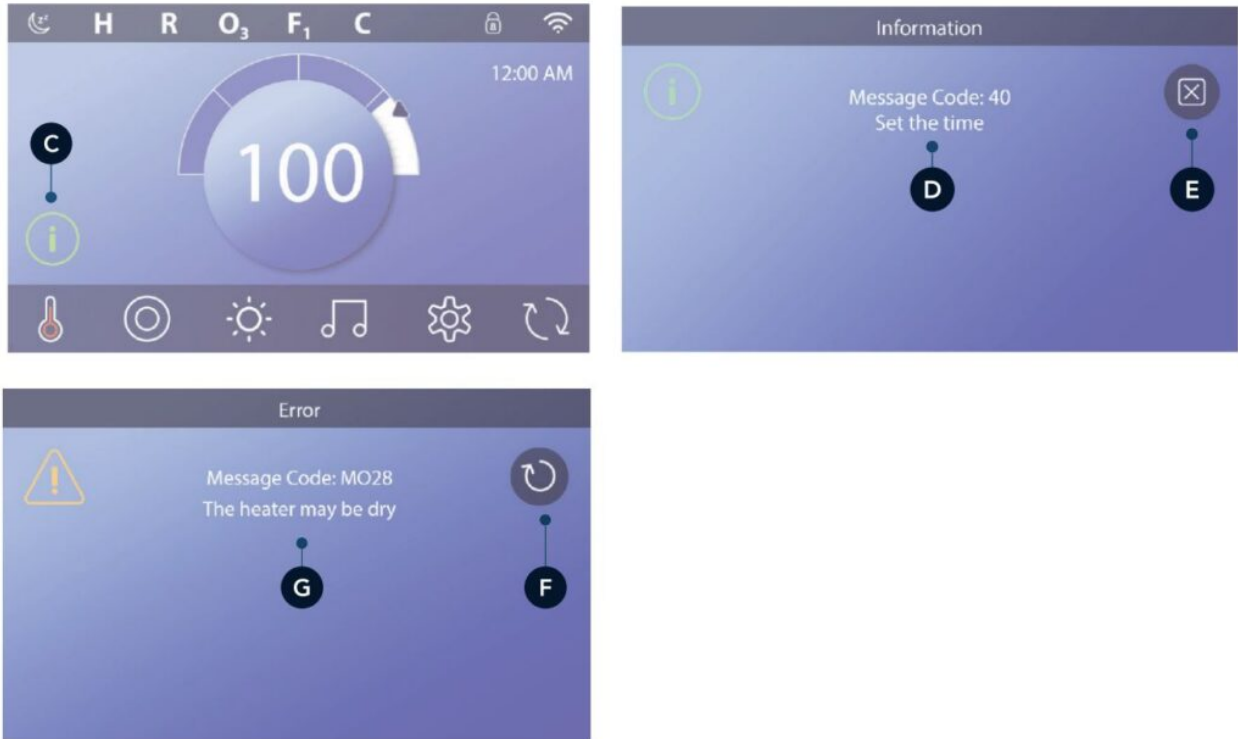

Buttons vary depending on the type of message. View the list below.



Information Message



Error-Spa will not function until fixed



Reminder Message



Clear Button





Error - Normal Error or Warning



Exit Button

## SETTINGS SCREEN | TOUCH PANEL

Fine tune your spa with a wide variety of Settings.

Starting from the Main screen, press the Settings button  to view the Settings screen (A). Press the navigation arrows or  swipe to view all of the Settings screens.

### HEAT

Make sure your spa is heated and ready to enjoy with Heat Settings.

### FILTER

Keep your spa water clean and ready to enjoy by setting Filter Cycles.

## TIME

Set the Time to insure scheduled features have proper timing.

## REMINDERS

Reminders (A) are helpful spa maintenance messages that display periodically.

## LOCKS

Lock the Panel and/or Setting.

## LIGHT CYCLE (Optional)

If you want the spa lights to turn On and Off at a specific times, use Light Cycle (A).

## HOLD

Hold (B) is used to disable the pumps during service functions like cleaning or replacing the filter. Hold Mode will last for 1 hour unless the mode is exited manually. If spa service will require more than an hour, it may be best to simply shut down power to the spa.

The Hold Icon on the Settings Screen places the spa in Hold Mode and displays the System Hold screen. Touch Back to exit Hold Mode

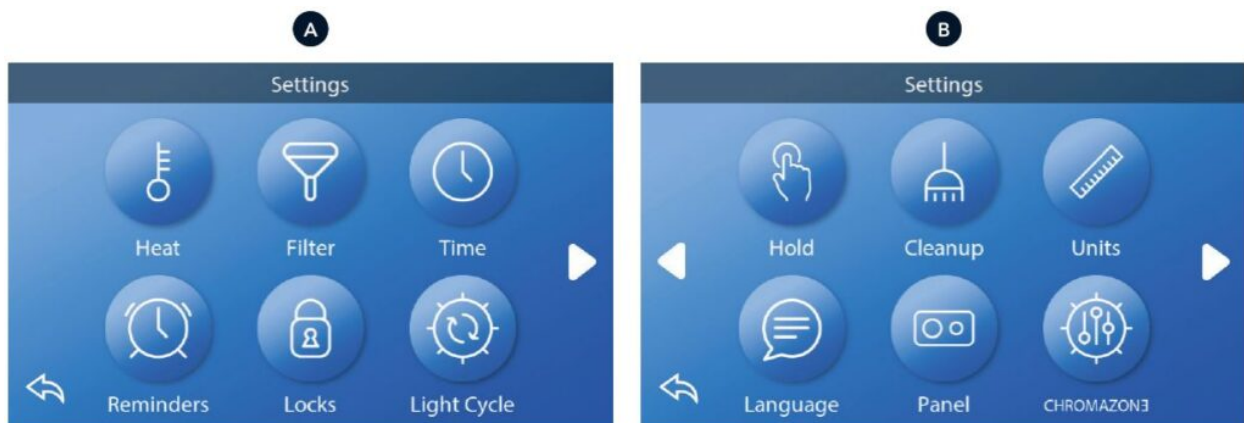

## HOLD (continued)

### Drain Mode (Optional)

Some spas have a special feature that allows Pump 1 to be employed when draining the water. When available, this feature is a component of Hold.

## CLEANUP

When a pump or blower is turned on by a button press, a clean-up cycle begins 30 minutes after the pump or blower is turned off or times out. The pump and the ozone generator will run for 30 minutes or more, depending on the system. On some systems, you can change this setting.

## UNITS

Specify Time and Temperature Units (B). The temperature choices are Fahrenheit or Celsius. The time display choices are 12 hours or 24 hours.

## LANGUAGE

Select from a variety of languages.

## PANEL

You can change two options on the Panel screen:

- 1 – Set how long it takes the panel to go to sleep after the last activity. Short times are recommended because it decreases the chance of water activating buttons.
- 2 – Set whether or not you need to do an extra action to wake the panel (see page 6). The purpose of the extra action to wake the panel is to make it very unlikely that water can wake the panel.

## CHROMAZON?™ (continued)

If your spa is equipped with CHROMAZON?™, refer to the CHROMAZON?™ user guide that came with the spa. If a user guide was not included, please contact the spa dealer or manufacturer.

## DIAGNOSTICS

Spa technicians can find useful information and features in Diagnostics (C).



## 5.3. Jets operation

The water jets provide a hydrotherapy pressure jet. It is a closed circuit, where the water is

absorbed by 1 or 2 pumps (depending on the SPA model) through the drain and driven to the jets.

The hydromassage effect is provided by the jet, when the circuit water mixes with the outside air, in the so-called Venturi effect.

To adjust the amount of air driven into the jets, simply turn the air input tab (venturis) as follows.

Each air inlet activates a certain group of jets.

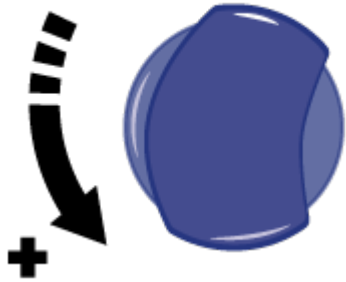

Some jets can also adjust the flow intensity on opening and closing the water flow. To do this, proceed as follows:

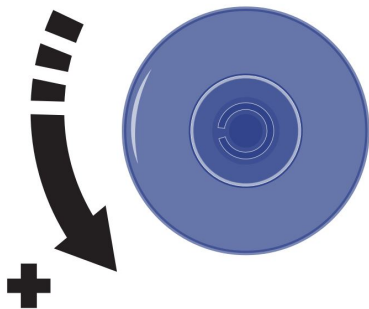

#### **ATTENTION**

Do not attempt to turn the outer ring of the jet, forcing it because you could damage it.

### **5.4. Level sensors**

The level sensors prevent functions from being activated when there is no water. This does not affect the functionality of the light cycle function.

Sensors hidden  
inside the shell

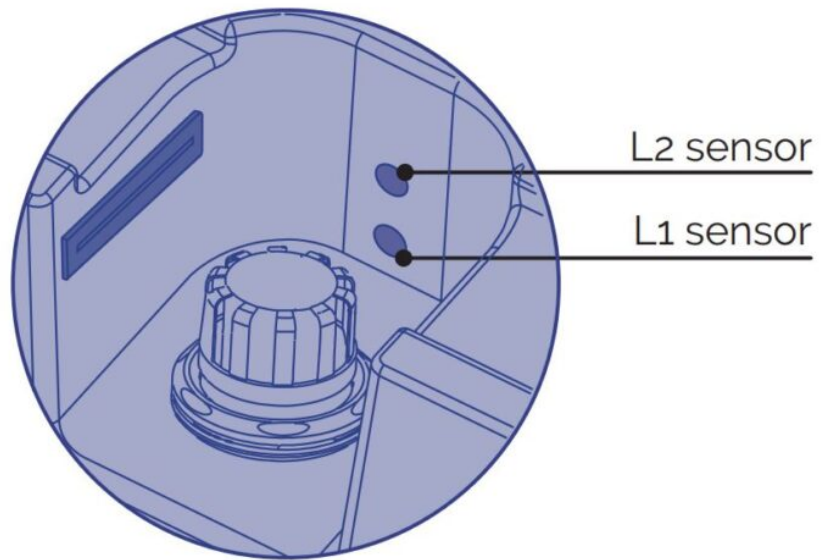

Level L1 is considered safe provided that the sensor detects water for at least 3 consecutive seconds. If water is not detected for that length of time, it remains off, thus activating the automatic filling procedure.

If the water level is below the L1 sensor, all the hot tub's functions are disabled, and the message "ERROR" is displayed on the control panel. When a suitable water level is detected again, the functions are enabled again.

When the water reaches the maximum level sensor (L2) and continues to be detected for 10 consecutive seconds, it disables automatic filling. If the water level is below the L2 sensor, automatic filling is activated.

## 5.5. Extras

### AUDIO

For cleaning the stereo and speakers, avoid cleaning with high pressure water, such as high pressure washing or with the hose nozzle.

The system consists of a subwoofer as well as two speakers strategically located in the cabinet. With this system, you can connect your mobile devices to the Spa.

1. Open Bluetooth device
2. Select 'BBA Spa Music' from the list of devices available to pair (no password required)

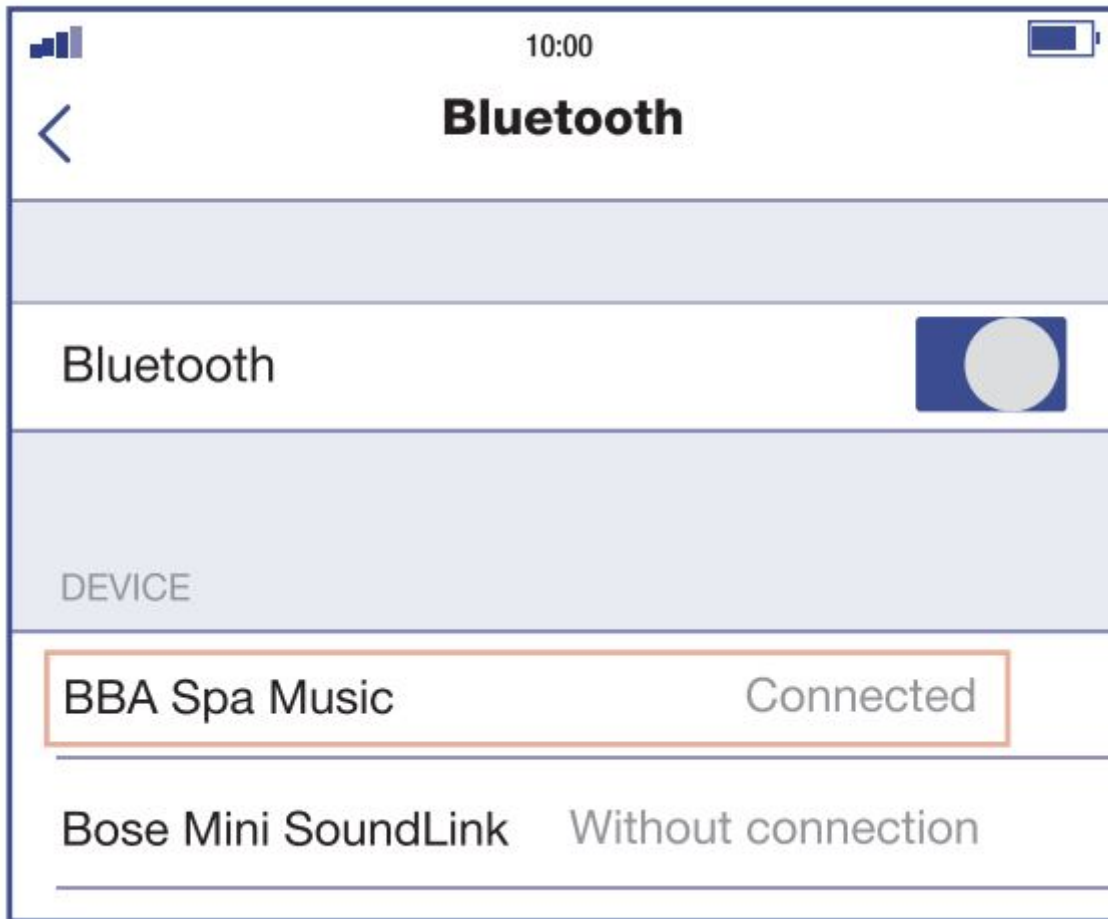

### **BLUETOOTH SURROUND SOUND**

The system is equipped with a subwoofer (subwoofer) and four speakers. Use the Bluetooth function to connect the sound system to your tablet or smartphone. In addition, you can listen to your favorite AM / FM radio stations and connect an auxiliary input cable or USB flash drive. The LED display will tell you what is playing.



bba<sup>TM</sup>3 works with iOS and Android phones and tablets.

Built in power supply: The bba<sup>TM</sup>3 connects to the control system at the circuit board connector labeled "A/V".



1. Power on the system pack with bbaTM3 already connected to the system pack

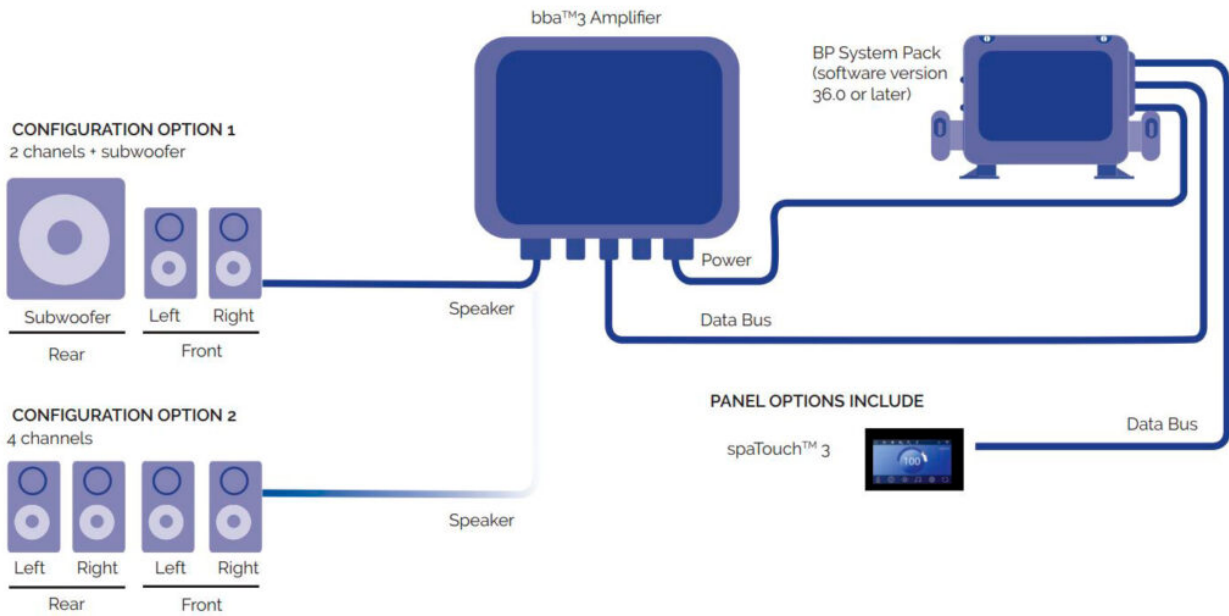

2. On the top panel press the music button. Then the power button.



3. Turn on Bluetooth function of your smart device or music device.

4. On your smart device or music device, click Search for Bluetooth device. Make sure you are close enough to the spa.

5. Select "PPME70BT" in the pairing list.

6. Click on «Connect». Once connected, you can now play your favorite music from your smart device or music device.

bba2 operates up to 100 feet in open air. Ranges vary as they are dependent on installations.

NOTE: If this message appears, it means that the equipment is NOT connected to the Bluetooth of the mobile device.





○ Open / Close button Audio

○ Indicator to active bluetooth

○ Configurations

○ Silence Audio

## 6. Maintenance

Our hot tubs are made with the highest-quality and most durable materials available. Proper care and maintenance will ensure the long service life of your hot tub and its components.

### 6.1. Warnings

- Before performing any electrical or mechanical maintenance work, make sure that the machine has been disconnected from the power supply and that the start-up devices have not been locked out.

- Do not handle the equipment with a wet body or feet.
- You must disconnect the power supply before performing any work on the hot tub (residual-current device in OFF position or disconnect the cable from the mains).
- This system cannot be connected to a simple plug.
- It requires a suitable electrical installation. This should be done by a qualified person, following the electrical safety regulations applicable in each country.
- The hot tub's power supply must always be protected by a highly sensitive residual current device. We recommend a 30mA residual-current device.
- Earthing is essential. The building's earth circuit must always be in a perfect condition to guarantee the safety of the hot tub user. If in doubt, get a suitably qualified person to check your earth circuit. The manufacturer will not be liable for any injury and/or damage caused by inadequate maintenance of the earth circuit.
- Use a cable with a cross-sectional area that is suitable for the hot tub's power and the distance to the electrical panel.
- Always follow the instructions in Precautions and preventive measures.
- Do not attempt to access any electrical component if you are not technically trained.
- Never access the electrical components if you have wet feet.
- The building's electrical system must have a mechanism to disconnect the hot tub from the mains supply, in accordance with the current regulations.

## 6.2. Water maintenance

Water maintenance is a point that requires the user's closest attention, due to its importance. This maintenance will depend on the mineral content of the water used, how often the hot tub is used and the number of people who use it.

Improper use of chemicals can result in degradation, damage and other damage to the spa surface and other components (discoloration of materials or corrosion of metal parts).

Chemicals are available to help remove bio-particles and are recommended for periodic use immediately prior to a drain or whenever there is a problem.

There are three key points for water maintenance:

- Water filtration
- Chemical analysis and pH control
- Water disinfection

### ANTI-FREEZE PROTECTION

If the temperature sensors detect a drop in temperature to below 6.7°C, the heating element and filter pump will connect automatically to prevent the water from freezing and the damage this could cause to the hot tub.

The equipment will remain connected for 4 minutes after the temperature reaches 7.2°C.

In colder climates, an additional temperature sensor can be added as a precaution and to avoid freezing conditions not detected by the standard sensor.

If the pump turns off in this situation, empty the Spa and contact your authorised dealer or Technical Assistance Service.

## SAFE USE OF CHEMICALS

Before using any chemical, carefully read the instructions for use provided by the manufacturer on the product's label.

- We recommend that the same person always uses the chemicals.
- Keep these products out of reach of children.
- Add the exact specified amounts to the water. Neither too much nor too little.
- Keep containers closed, in dry and well-ventilated places.
- Do not inhale chemicals and do not allow them to contact your eyes, nose or mouth. Wash your hands after using them.
- Follow the emergency instructions that appear on the product's label in the event of an accident or if ingested.
- Avoid smoking when handling these products. They may be flammable.
- Store these products in a suitable place, never inside the hot tub's cabinet.
- Do not mix the products together. Add them to the water one at a time. This avoids any unwanted chemical reactions between them.
- Do not add chemicals into the water while there are people inside the hot tub.
- Spa chemicals should be added according to the manufacturer's recommendation.

## MAINTENANCE SCHEDULE OF THE HOT TUB WATER

All chemicals: chlorine, bromine tablets, algaecides, calcium descales and pH reducer/ increaser, etc. must be poured into a floating dispenser (not supplied), with the massage pump running for at least ten minutes.

## ADJUSTING THE PH

A pH value between 7.2 ppm and 7.6 ppm is recommended. PH level measures acidity and alkalinity. Values above 7 ppm are alkaline; below 7 ppm they are acidic.

### ATTENTION

It is extremely important to maintain a correct pH level, to ensure that the disinfectant works properly and to avoid any corrosion or scaling in the hot tub. Any damage caused by an inadequate pH level is not covered by your spa guarantee 

If the pH level is very low, it has the following effects:

- The disinfectant will dissipate quickly.
- The hot tub's equipment may begin to corrode.
- The water may start to cause irritation to bathers.

If the pH level is very high, it has the following effects:

- The disinfectant is less effective.
- Scaling will appear on the acrylic and on the equipment.
- The water may turn cloudy.
- The pores in the filter cartridge may become clogged.

Check the water's pH level daily with the pH test kit.

If the pH level is too high, use pH MINUS for hot tubs. Wait for two hours before testing the pH level again. If the pH level is too low, use pH PLUS for hot tubs. Wait for two hours before testing the pH level again.

When the pH level is within the above range, follow the instructions below.

## **WATER DISINFECTION**

Disinfecting the water is vitally important to destroy algae, bacteria and organisms that can grow in the water. However, over-disinfecting can cause irritation to skin and eyes.

Bromine tablets are the most suitable water disinfectant for your hot tub. This product is placed in the pre-filter to gradually dissolve. Check the level of residual bromine every day using the bromine test kit. We recommend residual bromine levels between 2.2 and 3.3 ppm.

If using chlorine, to ensure that it is effective, you should maintain a free residual chlorine concentration between 0.5 and 1.5 ppm.

## **USING SPECIAL PRODUCTS**

As well as products to maintain pH and disinfectant levels, there are other products that are specially formulated for use in hot tubs, which will help you to keep the water and equipment in perfect condition.

- **DESCALER FOR HOT TUBS:** Prevents build-ups of calcium salts (scaling), especially in hard water. This product is added weekly and every time that the water is changed.
- **ALGASTOP FOR HOT TUBS:** This algacide prevents algae from growing in the hot tub's water. This product is added weekly and every time that the water is changed.
- **ANTI-FOAM FOR HOT TUBS:** Due to the water being agitated and the oils present in the water, foam is often formed. When a substantial amount of foam is observed in the water, remove it with CTX Anti-Foam for hot tubs.
- **WATERLINE CLEANER FOR HOT TUBS:** To eliminate the rings of dirt and grease that form on the hot tub's walls. To use this product, we recommend draining the water from the hot tub and applying the degreaser onto the areas being cleaned with a sponge. Then rinse with plenty of water.

## **U.V. DISINFECTION**

Ultraviolet rays (UV-C) allow water to be disinfected without using chemicals. When bacteria, viruses and protozoa are exposed to wavelengths between 200-300 nanometers (range C), these waves become a quick and effective germicide, preventing microorganisms from reproducing and contaminating the water.

Moreover, disinfection with UV-C rays is considered environmentally friendly, chemical free, and highly effective at disinfecting the water and protecting it against harmful microorganisms. This disinfecting component is located after the filtration pump and before the electric heater. A lamp inside the unit emits UV-C rays that disinfect the water as it flows through it.

## **QUICK GUIDE TO USING CHEMICALS**

	Reason for use	Quantity per m <sup>3</sup> of water	Frequency of use
--	----------------	--------------------------------------	------------------

pH minus hot tub	Add if the results of the pH test are above the permissible values (7.2-7.6 ppm).	Add as recommended by the manufacturer of the chemical.	Add pH daily with each pH test.
pH plus hot tub	Add if the results of the pH test are below the permissible values (7.2-7.6 ppm)	Add as recommended by the manufacturer of the chemical.	Add pH daily with each pH test.
Chlorine tablets	Add if the results of the pH test are below the permissible values (0,5 - 1,5 ppm).	Add as recommended by the manufacturer of the chemical.	Add chlorine daily with each test.
Bromine tablets	Add if the results of the Br test are above the permissible values (2.2 - 3.3ppm).	Add as recommended by the manufacturer of the chemical	Add Br daily with each test.
Descale	To prevent build-ups of calcium salts (scaling)	Add as recommended by the manufacturer of the chemical.	Weekly and every time that the water is changed.
Alga stop hot tub	To prevent algae from growing in the water	Add as recommended by the manufacturer of the chemical.	Weekly and every time that the water is changed.
Waterline cleaner	To eliminate rings of dirt from the hot tub's walls	Scrub with a sponge, and then rinse with plenty of water	When dirt is seen on the walls of the hot tub.
Anti-Foam	Excess foam present in the water	Add as recommended by the manufacturer of the chemical.	When foam appears in the water.

### 6.3. Filter maintenance

It is very important to follow a regular routine of backwashing the filters with granular media or backwashing the cartridge filter, chemical cleaning and drying.

#### ATTENTION

It is advisable to periodically check the condition of the filter cartridge. If dirt is observed, it must be clean or replace it. Remember that a clogged filter produces a drop in the flow of water, can cause a malfunction of the Spa. The Spa should always operate with the pre filter and filter cartridge placed correctly. Never place objects that might clog the inlet of the filter. x

All hot tubs include a filter. Check the filter regularly and follow the maintenance instructions that appear below.

#### TELESCOPIC FILTER CLEANING

1. Disconnect the electrical equipment. Differential in OFF position.
2. Unscrew the top of the filter.
3. Remove the cartridge.
4. Clean the cartridge with water at low pressure.

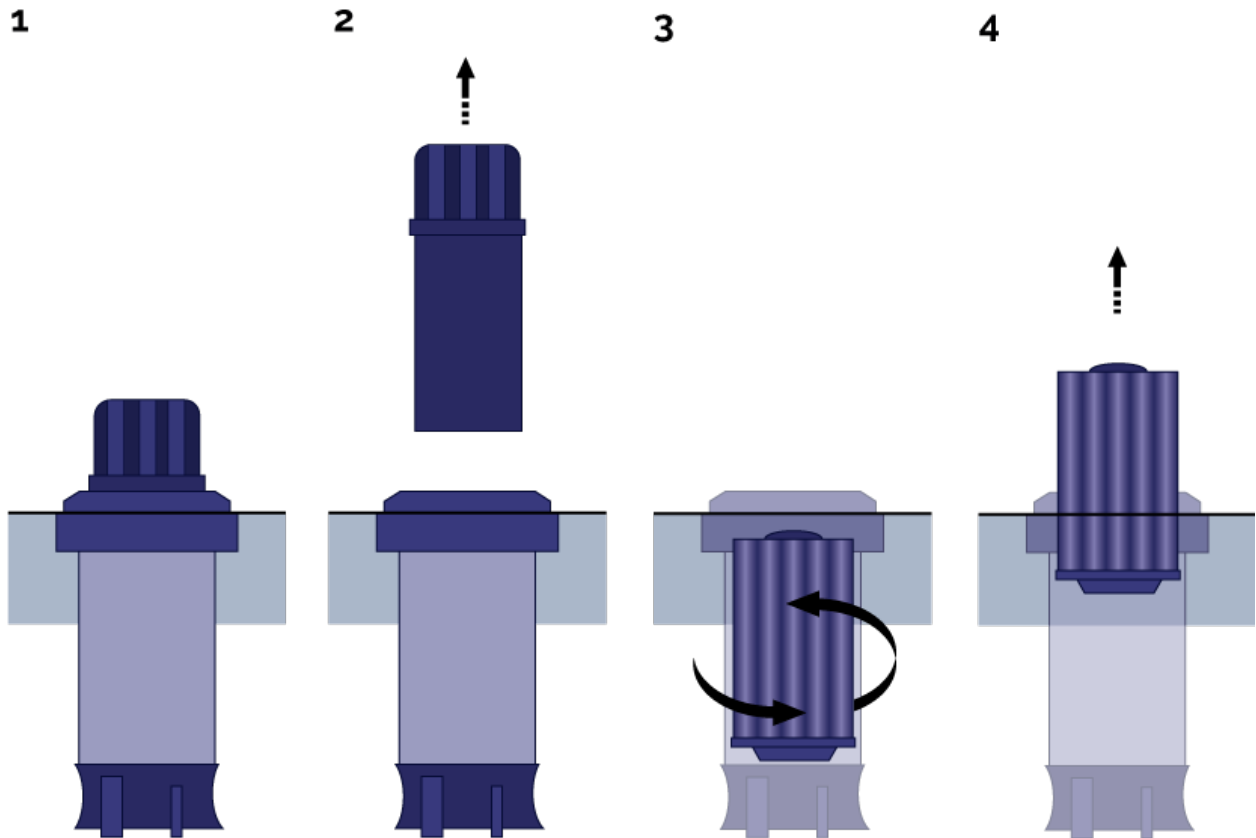

### ATTENTION

Remember to follow all the steps and to close the valve to avoid damaging the hot tub and prevent any accidents.

## 6.4. Pre-filter of the pump maintenance

It is recommended to periodically check the condition of the pre-filter of the pump to avoid it from blocking. If debris has accumulated, the pre-filter should be opened and cleaned.

Follow these steps to clean the pre-filter:

1. Turn off the Filtering Pump by placing the selector in the OFF position.
2. Close the valve of the filtering circuit that connects the pump to the Spa.
3. Using the key supplied with the equipment, turn the upper cover of the pre-filter anticlockwise until it becomes loose. Remove the basket of the pre-filter to clean it.
4. Put the basket back into place. Place the joint of the cover to close it using the key.
5. Open the filtering circuit valve.

## 6.5. Filter maintenance

Easy care for an attractive surface:

- Use common general-purpose cleaners. For normal care and cleaning, use a soft cloth or sponge with a little soap and water. Rinse well and dry with a clean, dry cloth.
- Never use abrasive cleaners. or cleaners with coarse grit. Avoid using hard paper tissue. These will dull the surface.
- Do not allow the acrylic surface to come into contact with ketones or esters such as acetone,

acetates (such as nail varnish remover, nail varnish or dry-cleaning substances) or any organic solvent with chlorine, varnishes, petrol, aromatic solvents, etc.

- Remove dust, mud and dry dirt with a soft damp cloth.
- Clean grease, oil, paint and ink stains with isopropyl alcohol and dry with a clean, dry cloth.
- Avoid using razors or any other type of sharp instrument that could scratch the surface. Small scratches can be removed by applying a thin layer of car paste wax and buffing it gently with a dry cloth.
- Do not use trichloro and dichlor tablets in spas, they can damage the shell surface.
- Make sure a good quality spa cover is securely in place when the spa is not in use. This will reduce the risk of stress cracking due to temperature difference between an exposed spa rim and the spa shell surface that is covered in water. Do not use steam jets to clean shell surfaces.
- Once a week, clean the part of the hot tub that is not submerged in water with a high-quality polish for hot tubs.

### **ATTENTION**

Remember never to expose the hot tub to sunlight when it is uncovered and empty, as this may lead to damage that is not covered by the warranty. 

## **6.6. Light maintenance**

The only spotlight maintenance that may be required is the replacement of the lamp. Follow the steps below to replace the lamp. It is not necessary to drain the water from the hot tub:

1. Remove the wooden panel on the side where the hot tub's spotlight is installed, using a screwdriver if necessary.
2. To replace the lamp, turn the bulb socket anticlockwise and remove the lamp and replace it.
3. After replacing the faulty lamp with a new one, return the bulb socket to its housing and reinstall the hot tub's wooden side panel.

If you are unsure or have questions about the above process, contact your dealer or authorised technical service.

### **WARNING- RISK OF ELECTRIC SHOCK**

Make sure that no power is being supplied to the hot tub.

The new lamp must have the same characteristics as the one supplied with the hot tub.

Never install a lamp without a front lens.

Make sure that it is properly sealed. Check the condition of the gasket and replace it. 

## **6.7. Maintenance in periods of non-use or absence**

### **SHORT PERIODS (3-5 days)**

- Adjust the pH and treat the water (see section 6.2. Water maintenance).
- Cover the hot tub.
- When you return, adjust the pH and treat the water again.

### **LONG PERIODS (5-14 DAYS)**

- Set the temperature to its lowest level.



- Adjust the pH and treat the water (see section 6.2. Water maintenance).
- Cover the hot tub.
- When you return, reset the temperature to the desired level and adjust the pH and treat the water again.

## PREPARING FOR THE WINTER PERIOD

If you do not use the hot tub during the winter or for very long periods, you must perform the following operations:

- Disconnect the electrical equipment, residual-current device's switch in the OFF position.
- Close the stopcocks for the water supply to the hot tub.
- Drain the water from the hot tub and all its pipes.
- Leave all the loop's valves open, remove all the pumps' drain plugs and disconnect the hot tub's water supply pipes, ensuring that they are completely empty.
- Clean and dry the hot tub.
- Cover the hot tub with the cover.

Do not leave water in the Spa without electrical connection at temperatures below 0°C, as the pipes can freeze and damage the spa.

### ATTENTION

Remember that when you drain your spa not all the water runs off. If your spa is not going to be used for long periods, especially in winter, remove any stagnant water on the seats and on the bottom of the spa with a sponge. Any water remaining in the pipes can be sucked out through the water and air nozzles using a liquid suction pump. The pumps must also be emptied through the drain plug.

You must comply with the regulations in force in each country on controlling Legionella. All responsibility for compliance rests with the owner. 

## 6.8. Cover maintenance

When the cover is not in use, it is recommended that it be kept off the floor so that it remains clean.

The cover should be checked to ensure that it fits snugly, according to the manufacturer's recommendations, for maximum insulation.

The cover should be stored in a suitable place where it will not suffer or cause damage.

It is recommended that the cover be cleaned both inside and out periodically with an appropriate solution including adequate disinfection (e.g. 10mg/l free chlorine).

Any appropriate system can be installed to ensure that the cover, especially the water facing side, does not come into contact with the ground or any other dirty surface when placed on top of the spa (e.g., a cover lift or a specific bracket attached to the spa).

It is recommended to place the cover in a clean and dry area, otherwise dirt and bacteria may accumulate. It should not be placed on wooden tables or floors because of the risk of discoloration of the wood. A deck hoist, or other similar device will be useful to ensure that it does not come into contact with the floor.

## 7. Error codes

Message	Meaning	Action required
<b>Water temperature is unknown</b>		After the pump has been running for 1 minute, the temperature will be displayed.
<b>Possible freezing condition</b>	A potential freeze condition has been detected, or the Aux Freeze Switch has closed.	All water devices are activated. In some cases, pumps may turn on and off and the heater may operate during Freeze Protection. This is an operational message, not an error indication.
The water is too hot – M029	The system has detected a spa water temp of 110°F (43.3°C) or more, and spa functions are disabled.	System will auto reset when the spa water temp is below 108°F (42.2°C). Check for extended pump operation or high ambient temp.
The water level is too low	This message can only appear on a system that uses a water level sensor. It appears whenever the water level get too low (or the water level sensor is disconnected)	Automatically disappears when the water level is adequate. Pumps and the heater turn OFF when this message appears.
The water flow is low – M016	There may not be enough water flow through the heater to carry the heat away from the heating element.	Heater start-up will begin again after about 1 min. See: **.
The water flow has failed – M017	There is not enough water flow through the heater to carry the heat away from the heating element and the heater has been disabled.	See: **.
The heater may be dry – M028	Possible dry heater, or not enough water in the heater to start it. The spa is shut down for 15 min.	See: **.
The heater is dry – M027	There is not enough water in the heater to start it. The spa is shut down.	After the problem has been resolved, you must reset the message to restart heater start up. See: **.
The heater is too hot – M030	One of the water temp sensors has detected 118°F (47.8°C) in the heater and the spa is shut down.	You must reset the message when water is below 108°F (42.2°C). See: **.

Flow-Related Checks		Check for low water level, suction flow restrictions, closed valves, trapped air, too many closed jets and pump prime.
Sensors are out of sync – M015	The temperature sensors MAY be out of sync by 3°F.	Call for Service if this message does not disappear within a few minutes.
Sensors are out of sync -- Call for service -- M026	The temperature sensors are out of sync.	The fault above has been established for at least an hour. Call for service. See **.
Sensor A Fault, Sensor B Fault – Sensor A: M031, Sensor B: M032	A temperature sensor or sensor circuit has failed.	If the problem persists, contact your vendor or a service engineer. See: **
Communications error	The control panel is not receiving communication from the System.	If the problem persists, contact your vendor or a service engineer.
Test software installed	The Control System is operating with test software.	If the problem persists, contact your vendor or a service engineer.
Program memory failure – M022	At Power-Up, the system has failed the Program Checksum Test.	This indicates a problem with the firmware (operation program) and requires a service call. See: **.
The settings have been reset (Persistent Memory Error) – M021		Contact your service organization if this message appears on more than one power-up. See: **.
The clock has failed – M020		If the problem persists, contact your vendor or a service engineer. See: **.
Configuration error (Spa will not Start Up)		If the problem persists, contact your vendor or a service engineer.
A pump may be stuck on – M034	Water may be overheated	POWER DOWN THE SPA. DO NOT ENTER THE WATER. Contact your dealer or service organization.
Hot fault – M035	A Pump Appears to have been Stuck ON when spa was last powered POWER DOWN THE SPA.	DO NOT ENTER THE WATER. If the problem persists, contact your vendor or a service engineer

\*\* Some messages can be reset from the panel. Messages that can be reset will appear with a Clear Icon at the bottom of the Message Screen. Press the Clear Icon text to reset the message.

## 8. Troubleshooting

Problems	Reasons	Solutions
----------	---------	-----------

Insufficient flow of filtered water.	Filter is blocked by dirt.	Wash the filter.
The massage pump of the Jets does not work. Spa does not work.	The cable of the digital control panel is disconnected from the board. No electrical supply. Differential is disconnected.	Connect the cable to the board. Check that the pump is connected to the electric control panel. Connect the differential
The massage pump of the air Blower does not work.	The cable of the digital control panel is disconnected from the board. No electrical supply. The pump has disconnected owing to overheating.	Connect the cable to the board. Check that the pump is connected to the electric control panel. Let it cool for about 3 hours and then start-up the pump again.
Water leaks out through the Venturi.	Jets are closed. Jets are not properly installed. The outer trim of the jet turns a quarter to open and close the water flow. If this trim makes a complete turn, it is not properly installed, and the jet will have to be removed and then placed correctly.	Open the jet. Remove the jet. Pull the outer trim about 2 cm. Unscrew the jet turning anticlockwise. Once it has been dismantled, replace the jet, by screwing in a clockwise direction. Press the outer trim back into place.
Limited airflow in the Jets	Venturis are closed.	Open the Venturis.
Reduced airflow.	Starter brushes of the motor are worn.	Change the pump.
The water does not reach the required temperature.	Probe is damaged. Check programmed temperature.	Replace the temperature probe. Program the temperature.

NOTE: In section 7. Error codes, you can find the diagnosis messages meaning to solve possible breakdowns.

## 9. Recycling and the environment

The Spa includes electric and/or electronic material, which at the end of its lifespan, should be suitably treated as special waste. Contact your local authorities to find out the collection and waste disposal procedure for electric and electronic material.



## 10. Evidence of conformity



**IBERSPA, S.L.**  
*Pol. Ind.*  
 Av. Pla d'Urgell 2-8  
 25200 - Cervera (Lleida)  
 (Spain)

**ES PRODUCTOS:**  
**EN PRODUCTS:**  
**DE PRODUKTE:**  
**FR PRODUITS:**  
**IT PRODOTTI:**  
**PT PRODUTOS:**  
**NL PRODUCTEN:**  
**RU продукт:**

**DA PRODUKTER:**  
**S PRODUKTER:**  
**FI TUOTTEET:**  
**N PRODUKTER:**  
**GR ΠΡΟΪΟΝΤΑ:**  
**PL PRODUCTY:**

**HOTEL SPA**

**ES - DECLARACION DE CONFORMIDAD**

Los productos arriba mencionados se hallan conformes a : Directiva 2014/30/UE (Compatibilidad Electromagnética), Directiva 2014/35/UE (Baja Tensión) y la Norma Europea EN 60335-2-41

**EN - EVIDENCE OF CONFORMITY**

The products listed above are in compliance with : 2014/30/EU (Electromagnetic Compatibility), Directive 2014/35/EU (Low Voltage) and with the European Standard EN 60335-2-41

**DE - KONFORMITÄTSERKLÄRUNG**

Die oben angeführten Produkte entsprechen den, Sicherheitsbestimmungen der Richtlinien der Elektromagnetischen Verträglich 2014/30/EU, der Niederspannungs Richtlinien 2014/35/EU, und der europäischen Vorschrift EN 60335-2-41

**FR - DECLARATION CONFORMITÉ**

Les produits mentionnés ci-dessus sont conformes aux : Directive Compatibilité Electromagnétique 2014/30/UE, Directive Basse Tension 2014/35/UE et à la Norme Européenne EN 60335-2-41

**IT - DICHIARAZIONE DI CONFORMITÀ**

I prodotti su elencati sono conformi alle seguenti : Direttiva 2014/30/UE (Compatibilità elettromagnetica), Direttiva 2014/35/UE (Bassa Tensione) e alla Norma Europea EN 60335-2-41

**PT - DECLARAÇÃO DE CONFORMIDADE**

Os produtos acima mencionado estão conforme a : Directiva 2014/30/UE (Compatibilidade Electromagnética), Directiva 2014/35/UE (Baixa tensão) e a Norma Europeia EN 60335-2-41

**NL - CONFORMITEITSVERKLARING**

Bovenstaande producten voldoen aan de veiligheidsvoorschriften van de Richtlijn Electromagnetische compatibiliteit 2014/30/EU, laagspannings richtlijn 2014/35/EU en aan de Europese norm EN 60335-2-41

**RU - ДЕКЛАРАЦИЯ СООТВЕТСТВИЯ**

Упомянутые выше модели соответствуют: Директиве 2014/30 / ЕС (об электромагнитной совместимости), Директиве 2014/35 / ЕС (о низком напряжении) и Европейскому стандарте: EN 60335-2-41

**DA - FÖRSÄKRAM OM ÖVERENSSTÄMMELSE**

Ovans ende produkter ä i överensstämmelse med : Direktiv 2014/30/EU (Elektromagnetisk kompatibilitet), Direktiv 2014/35/EU (L gspänning) och med Europeisk Standard EN 60335-2-41

**S - ÖVERENSSTEMMELESESERKL RING**

Ovst ende produkter oppfyller betingelsene elektromagnetiskdirektiv 2014/30/EU, lavspenningsdirektiv 2014/35/EU, og Europeisk Standard EN 60335-2-41

**FI - ÖVERENSSTEMMELESESERK RING**

Die ovst ende varer er i overensstemmelse med : Direktiv- 2014/30/EU (Elektromagnetisk forenelighed), Direktiv- 2014/35/EU (Lavsp nding) og i overensstemmelse med den europ iske standard EN 60335-2-41

**N - VAKUUTUS YHDENMUKAISUUDESTA**

Yllämainitut tuotteet ovat yhdenmukaisia direktiivin 2014/30/EU (Elektromagneettinen yhdenmukaisuus), direktiivin 2014/35/EU (Matalajännitelsekä eurooppalaisen standardin EN 60335-2-41

**GR - ΑΦΑΩΣΗ ΣΥΜΒΑΤΟΤΗΤΑΣ**

Τα παραπάνω προϊόντα είναι σύμφωνα με την Οδηγία 2014/30/ΕΕ, (Ηλεκτρομαγνητική Συμβατότητα) την Οδηγία 2014/35/ΕΕ (Χαμηλής Τάσης) και ε τον Ευρωπαϊκό Κανονισμό EN 60335-2-41

**PL - DEKLARACJA ZGODNOŚCI**

Wymienione powyżej produkty są zgodne z Dyrektywą 2014/30/UE (Kompatybilność Elektromagnetyczna), Dyrektywą 2014/35/UE (Niskie Napięcie) oraz Normą Europejską: EN 60335-2-41

Firma/Cargo:

Signature/Qualification:

Unterschrift/Qualifizierung:

Signature/Qualification:

Firma/Qualifica:

Assinatura/Título:

Handtekening/Hoedanigheid:

подпись / квалификация:

Namnteckning/Befattning:

Underskrift / Stilling:

Signatur/Tilstand:

Allekirjoitus/Vrka-asema:

Υγραφή/Θεση:

Podpisu/Stanowisko:

Gerente de Iberspa, S.L. PP  
 Manager of Iberspa, S.L. by proxy

© Iberspa, 2025